

KEMET Part Number: ESK107M025AE3AA
(SK107M025AE3AAPLP)

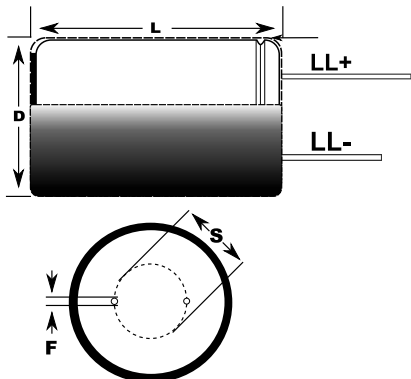

Capacitor, aluminum, 100 uF, +/-20% Tol, -40/+85C, 25VDC@85° C



Dimensions (mm)		
Symbol	Dimension	Tolerance
D	6	+0.8/-0.5
L	11	+1.5
S	2.5	+/-0.5
LLPos	20	MIN
LLNeg	15	MIN
F	0.5	

Packaging Specifications	
Package Kind:	Bulk
Package Quantity:	10000

General Information	
Supplier:	KEMET
Part Type Description:	Radial Cylindrical Aluminum Electrolytic
Style:	Radial Cylindrical
Lead Type:	Straight

Specifications	
Capacitance:	100 uF
Tolerance:	+/-20%
Rated Temperature:	85° C
Voltage @ rated temp:	25VDC
VDC Surge:	32VDC
Life @ rated temp:	2000 Hrs
RoHS:	Yes
Temperature Range:	-40/+85C
Leakage Condition:	2min/20c
Dissipation Factor:	14%
Ripple 120Hz @ rated temp:	0.2 A

Statements of suitability for certain applications are based on our knowledge of typical operating conditions for such applications, but are not intended to constitute - and we specifically disclaim - any warranty concerning suitability for a specific customer application or use. This Information is intended for use only by customers who have the requisite experience and capability to determine the correct products for their application. Any technical advice inferred from this Information or otherwise provided by us with reference to the use of our products is given gratis, and we assume no obligation or liability for the advice given or results obtained.



© 2006-2013 IntelliData.net