

IRF7701PbF

HEXFET® Power MOSFET

- Ultra Low On-Resistance
- P-Channel MOSFET
- Very Small SOIC Package
- Low Profile (< 1.1mm)
- Available in Tape & Reel
- Lead-Free

V_{DS}	$R_{DS(on)}$ max	I_D
-12V	0.011 @ $V_{GS} = -4.5V$	-10A
	0.015 @ $V_{GS} = -2.5V$	-8.5A
	0.022 @ $V_{GS} = -1.8V$	-7.0A

Description

HEXFET® power MOSFETs from International Rectifier utilize advanced processing techniques to achieve extremely low on-resistance per silicon area. This benefit, combined with the ruggedized device design, that International Rectifier is well known for, provides the designer with an extremely efficient and reliable device for use in battery and load management.

The TSSOP-8 package, has 45% less footprint area of the standard SO-8. This makes the TSSOP-8 an ideal device for applications where printed circuit board space is at a premium.

The low profile (<1.1 mm) of the TSSOP-8 will allow it to fit easily into extremely thin application environments such as portable electronics and PCMCIA cards.

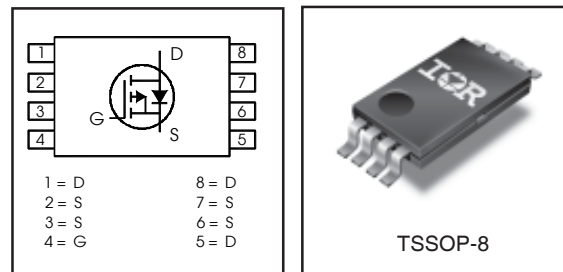

Absolute Maximum Ratings

	Parameter	Max.	Units
V_{DS}	Drain- Source Voltage	-12	V
$I_D @ T_A = 25^\circ C$	Continuous Drain Current, $V_{GS} @ -4.5V$	± 10	A
$I_D @ T_A = 70^\circ C$	Continuous Drain Current, $V_{GS} @ -4.5V$	± 8.0	
I_{DM}	Pulsed Drain Current ①	± 80	
$P_D @ T_A = 25^\circ C$	Power Dissipation	1.5	W
$P_D @ T_A = 70^\circ C$	Power Dissipation	0.96	
	Linear Derating Factor	12	mW/°C
V_{GS}	Gate-to-Source Voltage	± 8.0	V
T_J, T_{STG}	Junction and Storage Temperature Range	-55 to + 150	°C

Thermal Resistance

	Parameter	Max.	Units
$R_{\theta JA}$	Maximum Junction-to-Ambient ③	83	°C/W

Electrical Characteristics @ $T_J = 25^\circ\text{C}$ (unless otherwise specified)

	Parameter	Min.	Typ.	Max.	Units	Conditions
$V_{(BR)DSS}$	Drain-to-Source Breakdown Voltage	-12	—	—	V	$V_{GS} = 0V, I_D = -250\mu A$
$\Delta V_{(BR)DSS}/\Delta T_J$	Breakdown Voltage Temp. Coefficient	—	-0.006	—	V/°C	Reference to 25°C , $I_D = -1\text{mA}$
$R_{DS(on)}$	Static Drain-to-Source On-Resistance	—	—	0.011	Ω	$V_{GS} = -4.5V, I_D = -10A$ ②
		—	—	0.015		$V_{GS} = -2.5V, I_D = -8.5A$ ②
		—	—	0.022		$V_{GS} = -1.8V, I_D = -7.0A$ ②
$V_{GS(th)}$	Gate Threshold Voltage	-0.45	—	-1.2	V	$V_{DS} = V_{GS}, I_D = -250\mu A$
g_{fs}	Forward Transconductance	21	—	—	S	$V_{DS} = -10V, I_D = -10A$
I_{DSS}	Drain-to-Source Leakage Current	—	—	1.0	μA	$V_{DS} = -12V, V_{GS} = 0V$
		—	—	-25		$V_{DS} = -9.6V, V_{GS} = 0V, T_J = 70^\circ\text{C}$
I_{GSS}	Gate-to-Source Forward Leakage	—	—	-100	nA	$V_{GS} = -8.0V$
	Gate-to-Source Reverse Leakage	—	—	100		$V_{GS} = 8.0V$
Q_g	Total Gate Charge	—	69	100	nC	$I_D = -8.0A$
Q_{gs}	Gate-to-Source Charge	—	9.1	14		$V_{DS} = -9.6V$
Q_{gd}	Gate-to-Drain ("Miller") Charge	—	21	32		$V_{GS} = -4.5V$ ②
$t_{d(on)}$	Turn-On Delay Time	—	19	—	ns	$V_{DD} = -6.0V$
t_r	Rise Time	—	20	—		$I_D = -1.0A$
$t_{d(off)}$	Turn-Off Delay Time	—	240	—		$R_D = 6.0\Omega$
t_f	Fall Time	—	220	—		$V_{GS} = -4.5V$ ②
C_{iss}	Input Capacitance	—	5050	—	pF	$V_{GS} = 0V$
C_{oss}	Output Capacitance	—	1520	—		$V_{DS} = -10V$
C_{rss}	Reverse Transfer Capacitance	—	1120	—		$f = 1.0\text{MHz}$

Source-Drain Ratings and Characteristics

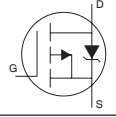
	Parameter	Min.	Typ.	Max.	Units	Conditions
I_S	Continuous Source Current (Body Diode)	—	—	-1.5	A	MOSFET symbol showing the integral reverse p-n junction diode. 
I_{SM}	Pulsed Source Current (Body Diode) ①	—	—	-80		
V_{SD}	Diode Forward Voltage	—	—	-1.2	V	$T_J = 25^\circ\text{C}, I_S = -1.5A, V_{GS} = 0V$ ②
t_{rr}	Reverse Recovery Time	—	52	78	ns	$T_J = 25^\circ\text{C}, I_F = -1.5A$
Q_{rr}	Reverse Recovery Charge	—	53	80	nC	$di/dt = 100A/\mu s$ ②

Notes:

① Repetitive rating; pulse width limited by max. junction temperature.

② Pulse width $\leq 300\mu s$; duty cycle $\leq 2\%$.

③ When mounted on 1 inch square copper board, $t < 10$ sec

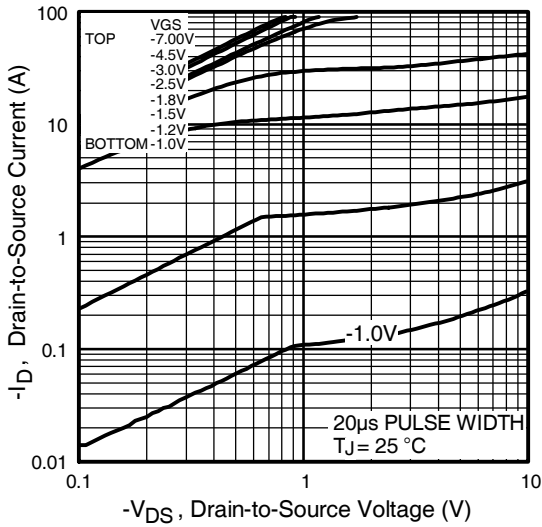

Fig 1. Typical Output Characteristics

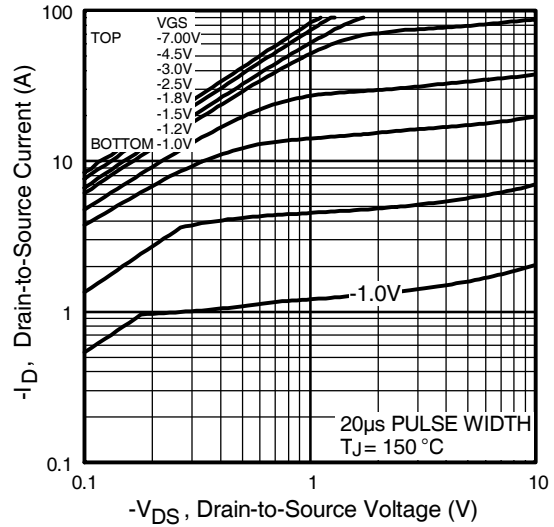

Fig 2. Typical Output Characteristics

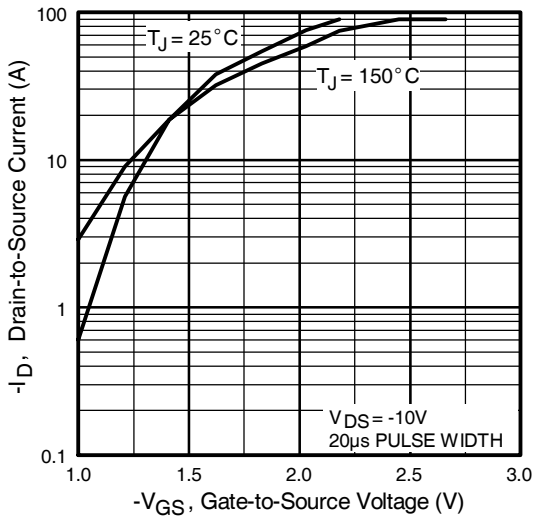

Fig 3. Typical Transfer Characteristics

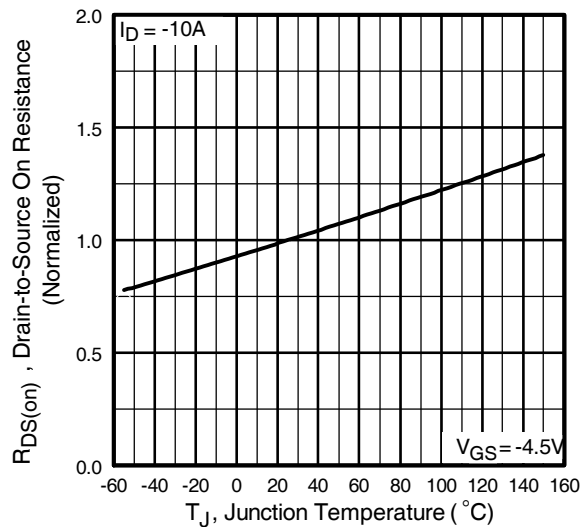

Fig 4. Normalized On-Resistance Vs. Temperature

IRF7701PbF

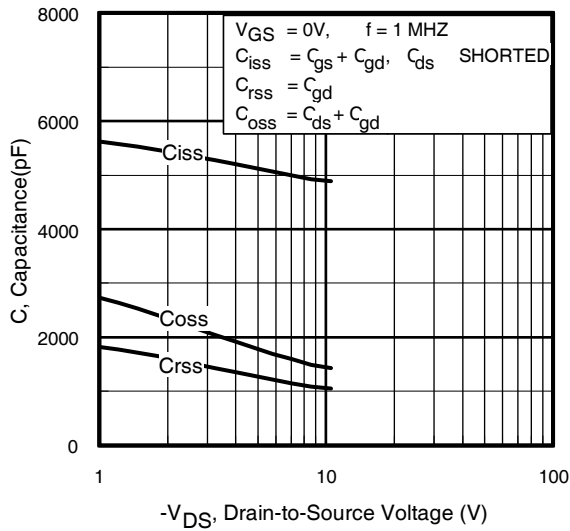

Fig 5. Typical Capacitance Vs. Drain-to-Source Voltage

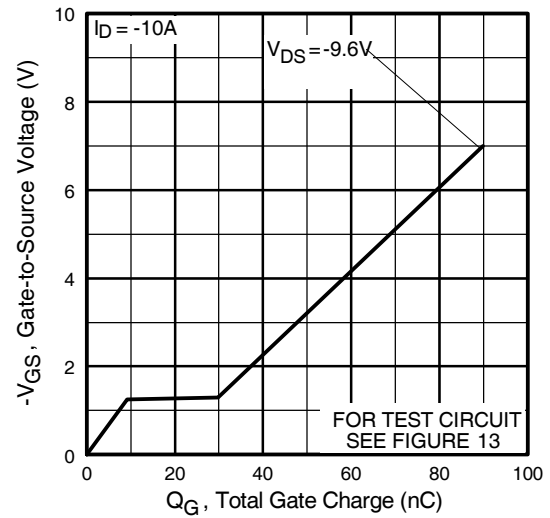

Fig 6. Typical Gate Charge Vs. Gate-to-Source Voltage

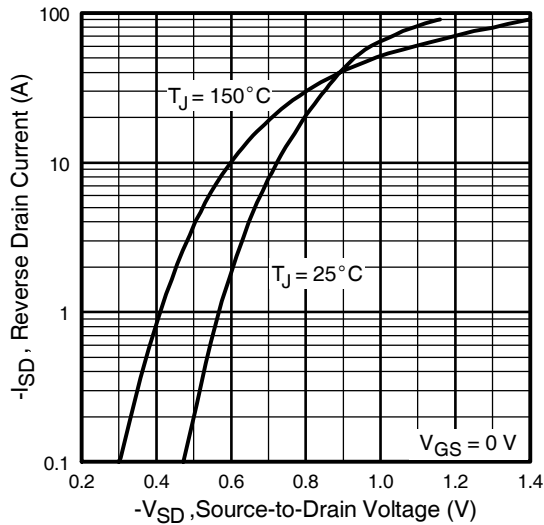

Fig 7. Typical Source-Drain Diode Forward Voltage

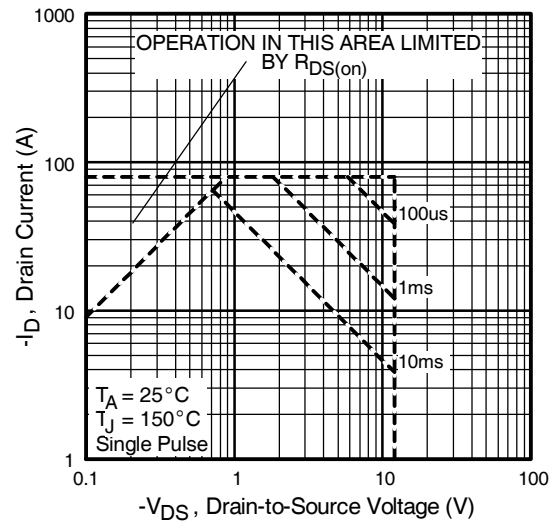

Fig 8. Maximum Safe Operating Area

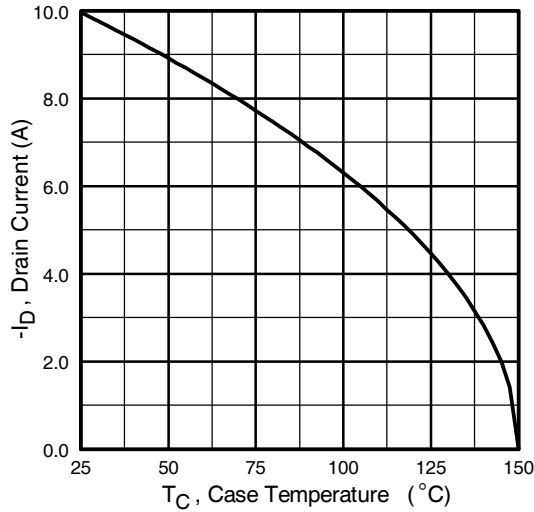

Fig 9. Maximum Drain Current Vs. Case Temperature

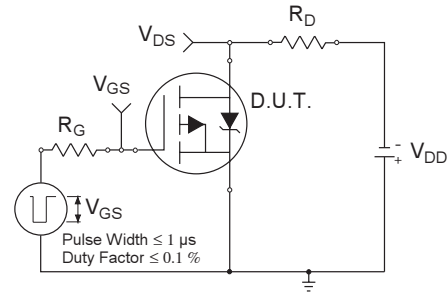

Fig 10a. Switching Time Test Circuit

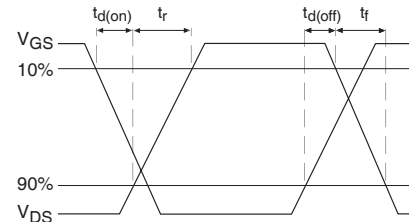

Fig 10b. Switching Time Waveforms

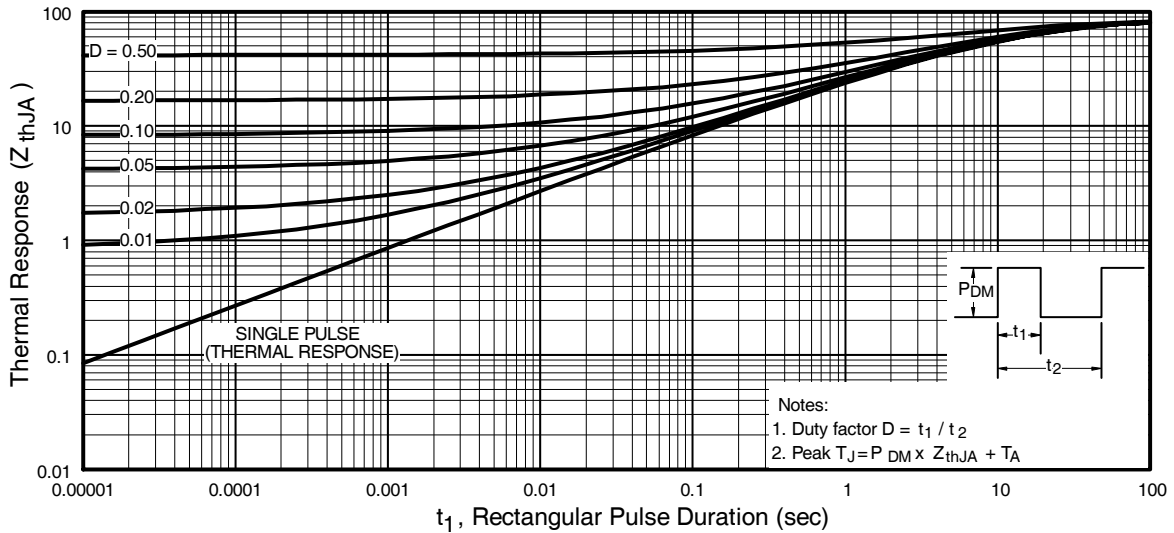

Fig 10. Typical Effective Transient Thermal Impedance, Junction-to-Ambient

IRF7701PbF

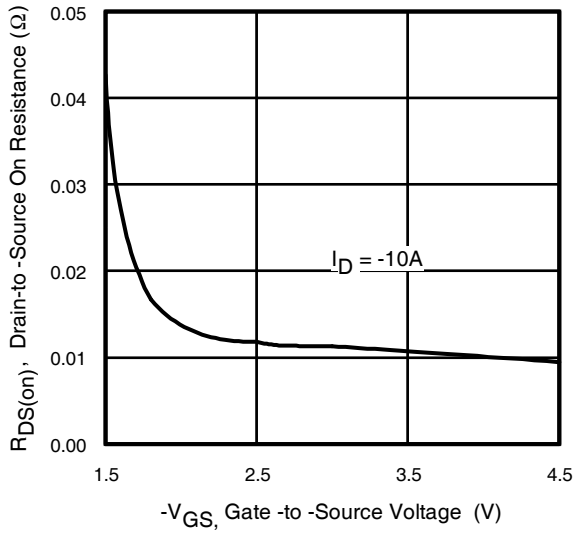

Fig 11. Typical On-Resistance Vs. Gate Voltage

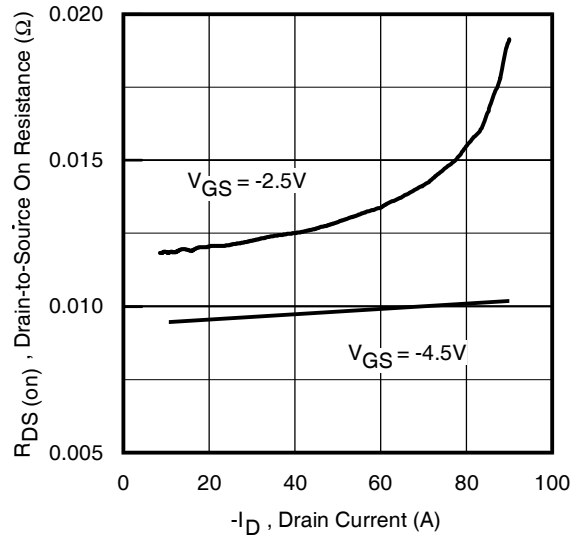

Fig 12. Typical On-Resistance Vs. Drain Current

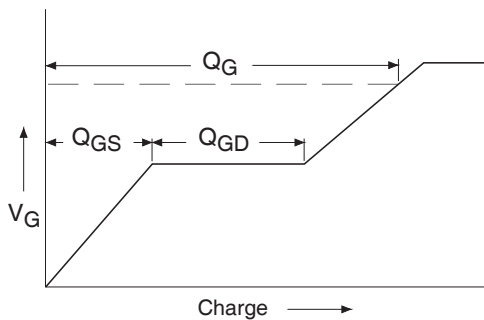

Fig 13a. Basic Gate Charge Waveform

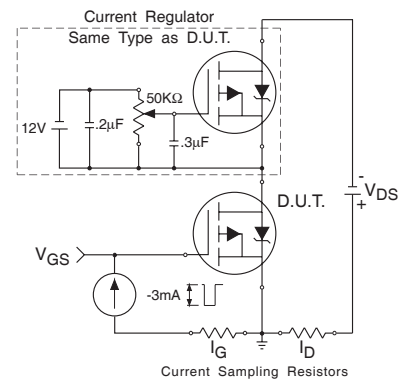

Fig 13b. Gate Charge Test Circuit

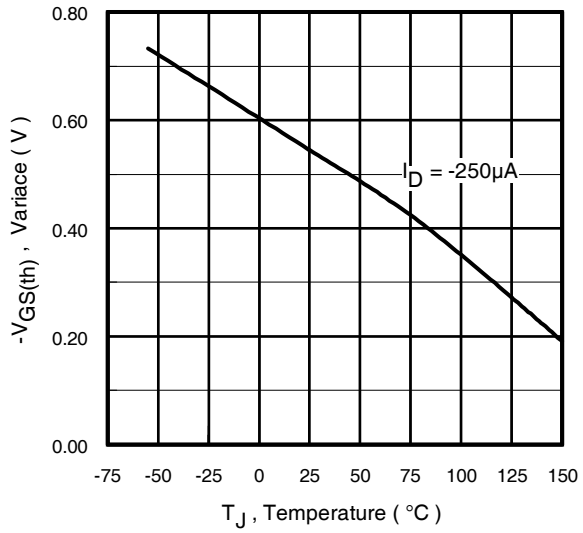

Fig 14. Threshold Voltage Vs. Temperature

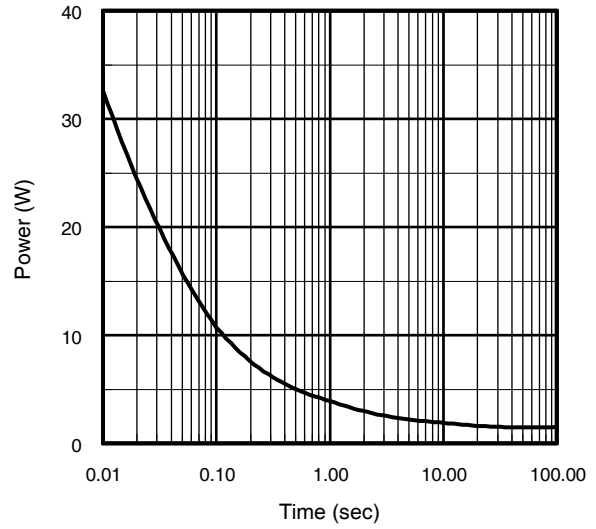
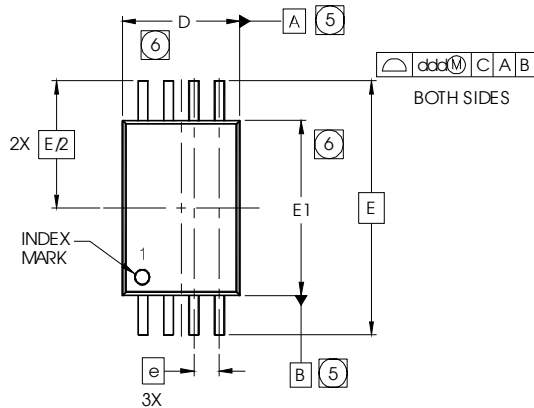

Fig 15. Typical Power Vs. Time

IRF7701PbF

TSSOP8 Package Outline

Dimensions are shown in millimeters (inches)



SYMBOL	MO-153AA DIMENSIONS					
	MILLIMETERS			INCHES		
	MIN	NOM	MAX	MIN	NOM	MAX
A	---	---	1.20	---	---	.0472
A1	0.05	---	0.15	.0020	---	.0059
A2	0.80	1.00	1.05	.032	.039	.041
b	0.19	---	0.30	.0075	---	.0118
c	0.09	---	0.20	.0036	---	.0078
D	2.90	3.00	3.10	.115	.118	.122
E	6.40 BSC			.251 BSC		
E1	4.30	4.40	4.60	.170	.173	.177
e	0.65 BSC			.0256		
L	0.45	0.60	0.75	.0178	.0236	.0290
L1	0.25 BSC			.010 BSC		
θ	0°	---	8°	0°	---	8°
aaa	0.10			.0039		
bbb	0.10			.0039		
ccc	0.05			.0019		
ddd	0.20			.0078		

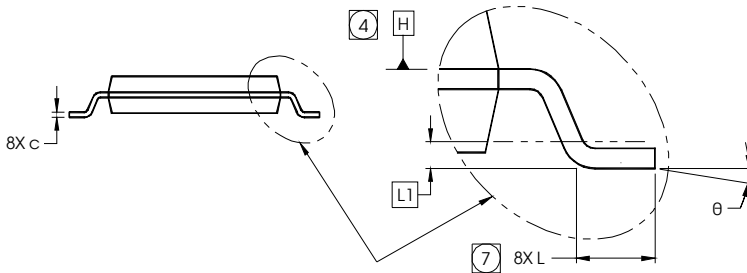
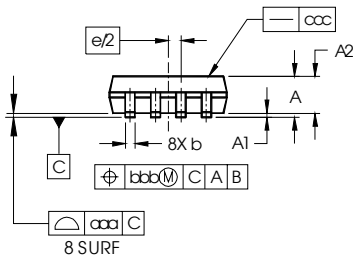

LEAD ASSIGNMENTS

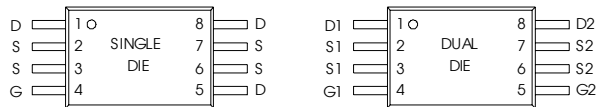

NOTES

1. DIMENSIONING AND TOLERANCING PER ASME Y14.5M-1994.
2. DIMENSIONS ARE SHOWN IN MILLIMETERS AND INCHES.
3. CONTROLLING DIMENSION: MILLIMETER.
4. DATUM PLANE H IS LOCATED AS SHOWN.
5. DATUM A AND B TO BE DETERMINED AT DATUM PLANE H.
6. DIMENSIONS D AND E1 ARE MEASURED AT DATUM PLANE H.
7. DIMENSION L IS THE LEAD LENGTH FOR SOLDERING TO A SUBSTRATE.
8. OUTLINE CONFORMS TO JEDEC OUTLINE MO-153AA.

TSSOP8 Part Marking Information

EXAMPLE: THIS IS AN IRF7702

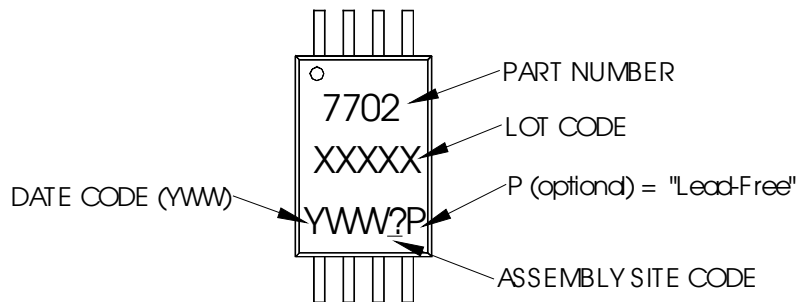

TSSOP-8 Tape and Reel Information

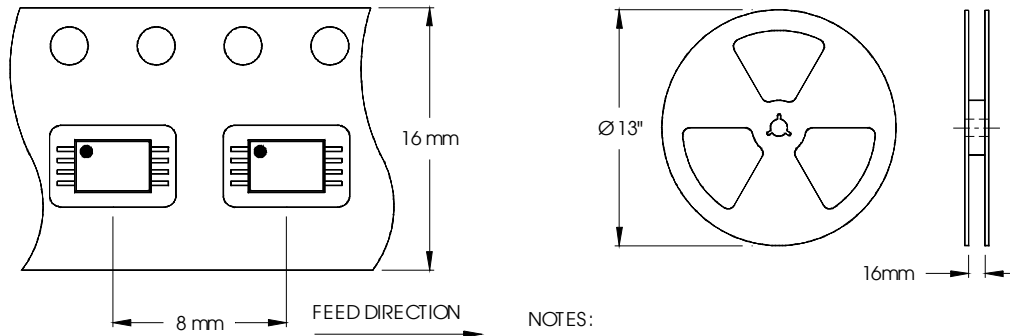

NOTES:

1. TAPE & REEL OUTLINE CONFORMS TO EIA-481 & EIA-541.

Data and specifications subject to change without notice.
 This product has been designed and qualified for the Consumer market.
 Qualification Standards can be found on IR's Web site.

International
IR Rectifier

IR WORLD HEADQUARTERS: 233 Kansas St., El Segundo, California 90245, USA Tel: (310) 252-7105
 TAC Fax: (310) 252-7903

Visit us at www.irf.com for sales contact information. 12/2006