

High Frequency Relay G6Y

Economical HF Relay Design Based on Micro Strip Line Technology

- Isolation characteristics of 65 dB or better at 900 MHz.
- Effective insertion loss of 0.2 dB (typical) at 900 MHz.
- Fully sealed construction.
- Improved shock-resistance.
- Form, fit and function replacement to G5Y relay with improved characteristics
- RoHS Compliant

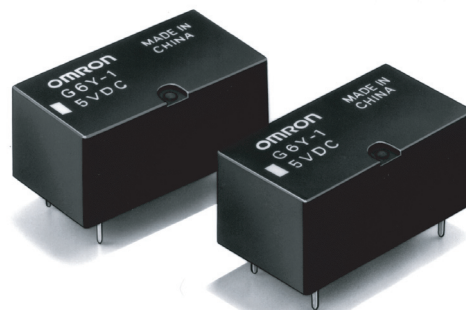

Ordering Information

To order: Select the part number and add the desired coil voltage rating (e.g. G6Y-1-DC12).

Type	Contact Form	Construction	Part Number
Standard	SPDT	Fully-sealed	G6Y-1

Model Number Legend

G6Y - - DC
1 2

1. Contact Form
1: SPDT

2. Rated Coil Voltage
4.5, 5, 9, 12, 24

Application Examples

- **Wired Communications:** Cable TV, captain systems, and video response systems
- **Wireless Communications:** Transceivers, ham radio, fax machines, satellite broadcasting, text multiplex broadcasting
- **Entertainment Equipment:** TVs, DVD players, and video games
- **Industrial Equipment:** Measuring equipment, test equipment, and multiplex transmission devices

Specifications

■ Contact Ratings

Load type	Resistive load
Contact Material	Au clad Cu alloy
Rated load	0.01 A at 30 VAC 0.01 A at 30 VDC 900 MHz, 1 W (See note.)
Rated carry current	0.5 A
Max. switching voltage	30 VAC 30 VDC
Max. switching current	0.5 A
Max. switching capacity (reference value)	AC10VA DC10W

Note: This value is for a load with V.S.W.R. of 1.2 max.

■ High-frequency Characteristics

Item	250 MHz	900 MHz	2.5 GHz
Isolation	80 db min.	65 dB min.	30 dB min.
Insertion loss	0.5 dB max.	0.5 dB max.	---
V.S.W.R.	1.5 max.	1.5 max.	---
Max. carry power	10 W		---
Max. switching power	10 W (See note 3.)		---

- Note: 1. The impedance of the measuring system is 50 Ω.
2. The table above shows preliminary values.
3. This value is for a load with V.S.W.R. of 1.2 max.

Coil Ratings

Rated voltage (VDC)	Rated current (mA)	Coil resistance (Ω)	Operating voltage (V)	Release voltage (V)	Maximum voltage (V)	Power consumption (mW)
4.5	44.4	101	75% max. of rated voltage	10% min. of rated voltage	150% of rated voltage at 23°C	Approx. 200
5	40.0	125				
9	22.2	405				
12	16.7	720				
24	8.3	2,880				

- Note:**
- The rated current and coil resistance are measured at a coil temperature of 23°C with a tolerance of $\pm 10\%$.
 - The operating characteristics are measured at a coil temperature of 23°C.
 - The maximum voltage is the highest voltage that can be imposed on the relay coil instantaneously. It is not the maximum voltage that can be applied continuously.

Characteristics

Contact resistance (See note 2.)	100 m Ω max.
Operating time	10 ms max. (approx. 5 ms, typ.)
Release time	5 ms max. (approx. 1 ms, typ.)
Insulation resistance (See note 3.)	100 M Ω min.
Dielectric strength	1,000 VAC, 50/60 Hz for 1 min between coil and contacts
	500 VAC, 50/60 Hz for 1 min between contacts of same polarity
	500 VAC, 50/60 Hz for 1 min between coil and ground and between contacts and ground
Vibration resistance	Destruction: 10 to 55 Hz, 1.5 mm double amplitude
	Malfunction: 10 to 55 Hz, 1.5 mm double amplitude
Shock resistance	Destruction: 1,000 m/s ² (approx. 100G)
	Malfunction: 500 m/s ² (approx. 50G)
Life expectancy	Mechanical: 1,000,000 operations min. (at 1,800 operations/hr)
	Electrical: 300,000 operations min. (under rated load at 1,800 operations/hr)
Ambient temperature	Operating: -40°C to 70°C (with no icing)
Ambient humidity	Operating: 5 to 85%
Weight	Approx. 5 g

- Note:**
- The table above shows preliminary values.
 - The contact resistance was measured with 100mA at 5VDC with a voltage drop method.
 - The insulation resistance was measured with a 500-VDC megohmmeter applied to the same points as those used for checking the dielectric strength.

Engineering Data

Ambient Temperature vs. Maximum Coil Voltage

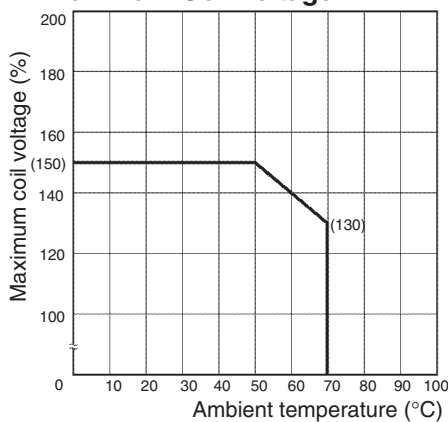

Note: The maximum coil voltage refers to the maximum value in a varying range of operating power voltage, not a continuous voltage.

Resistance to Shock

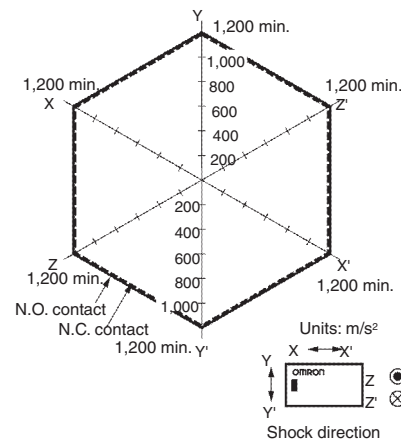

Quantity Tested: 10 Units Rating: 500 m/s²

Test Method: Shock was applied 3 times in each direction with and without excitation and the level at which the shock caused malfunction was measured.

High-frequency Characteristics
Measurement Conditions

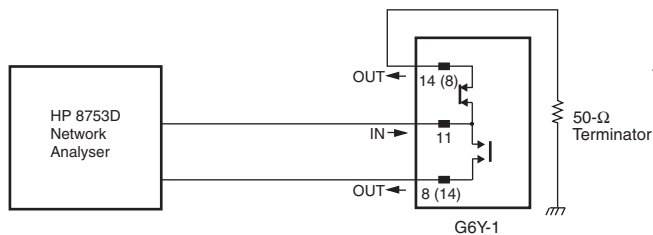

Terminals which were not being measured were terminated with 50 Ω.

Note: The high-frequency characteristics data were measured using a dedicated circuit board and actual values will vary depending on the usage conditions. Check the characteristics of the actual equipment being used.

Isolation, Average Values
 (See notes 1 and 2.)

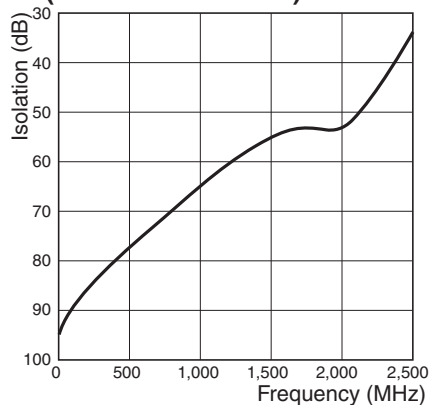

Insertion Loss, Average Values
 (See notes 1 and 2.)

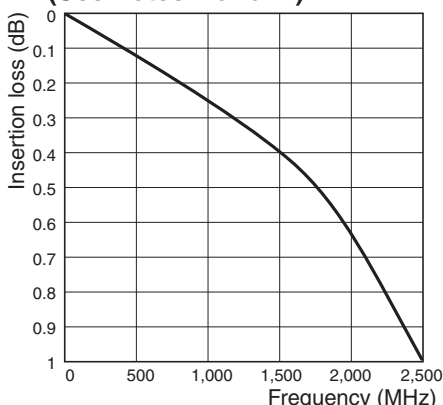

V.S.W.R. / Return Loss, Average Values
 (See notes 1 and 2.)

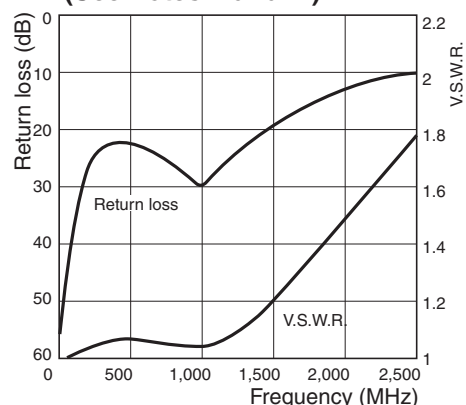

Operating/Release Time Distribution
 (See note 1.)

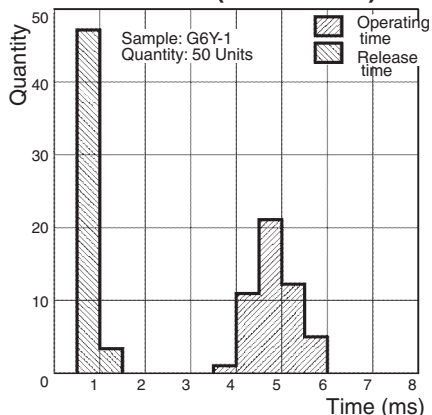

Bounce Time Distribution
 (See note 1.)

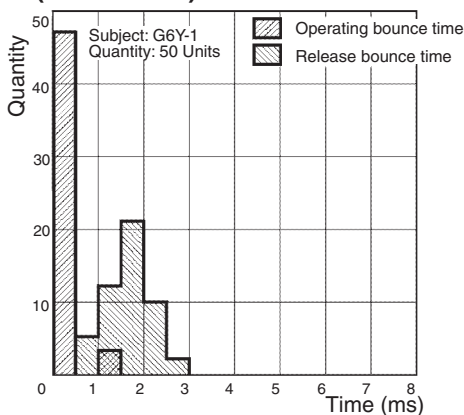

Note: 1. The tests were conducted at an ambient temperature of 23°C.

2. High-frequency characteristics depend on the PCB to which the Relay is mounted. Always check these characteristics, including endurance (life expectancy), in the actual machine before use.

Dimensions

Note: All units are in millimeters unless otherwise indicated.

G6Y-1

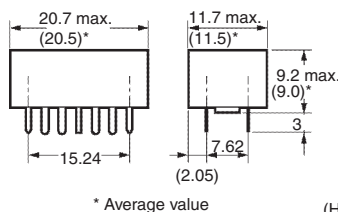
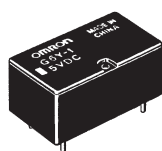

PCB Dimensions (Bottom View)

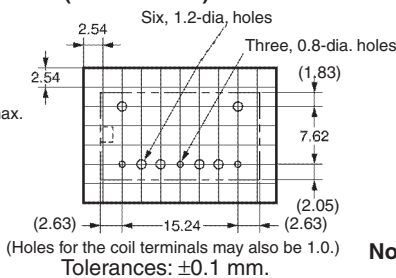

Terminal Arrangement/ Internal Connections (Bottom View)

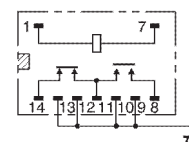

(There is no polarity to the coil.)

Note: The shaded and unshaded parts indicate the product's directional marks.

Precautions

■ Correct Use

Long-term Continuously ON Contacts

Using the Relay in a circuit where the Relay will be ON continuously for long periods (without switching) can lead to unstable contacts because the heat generated by the coil itself will affect the insulation, causing a film to develop on the contact surfaces. Be sure to use a fail-safe circuit design that provides protection against contact failure or coil burnout.

Seal integrity during cleaning will last 1 minute at 70°C. Complete cleaning within these conditions.

Micro Strip Line Design

- It is advantageous to use the Micro Strip Line in high-frequency transmission circuits because a low-loss transmission can be constructed with this method. By etching the dielectric base which has copper foil attached to both sides, the Micro Strip Line will have a concentrated electric field between the lines and ground as shown in the following diagram.

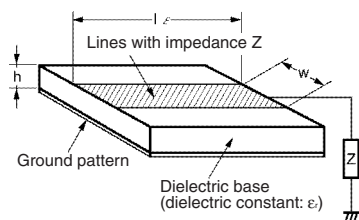

- The characteristic impedance of the lines Z_0 is determined by the kind of base (dielectric constant), the base's thickness, and the width of the lines, as expressed in the following equation.

$$Z_0 = \frac{377}{\sqrt{\epsilon_r} \frac{W}{H} \left\{ 1 + \frac{2H}{\pi W} \left[1 + \ln \frac{\pi W}{H} \right] \right\}}$$

W: Line width

ϵ_r : Effective dielectric constant

H: Dielectric base thickness

The copper foil thickness must be less than H.

- The following graph shows this relationship.

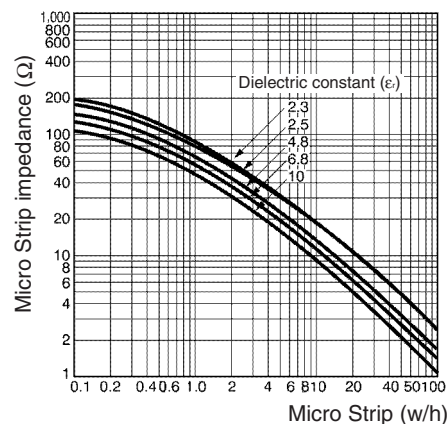

- For example, when creating 50-Ω lines using a glass epoxy base with a thickness of 1.6 mm, the above graph will yield a w/h ratio of 1.7 for a dielectric constant of 4.8. Since the base thickness is 1.6 mm, the width will be $h \times 1.7 \approx 2.7$ mm. The thickness of the copper foil "t" is ignored in this design method, but it must be considered because large errors will occur in extreme cases such as a foil thickness of $t \approx w$. Furthermore, with the Micro Strip Line design, the lines are too short for the G6Y's intended frequency bandwidths, so we can ignore conductive losses and the line's attenuation constant.
- The spacing of the Strip Lines and ground pattern should be comparable to the width of the Strip Lines.
- Design the pattern with the shortest possible distances. Excessive distances will adversely effect the high-frequency characteristics.
- Spread the ground patterns as widely as possible so that potential differences are unlikely to develop between the ground patterns.
- To avoid potential short-circuits, do not place the pattern's leads near the point where the bottom of the Relay attaches to the board.

Bending the Micro Strip Line

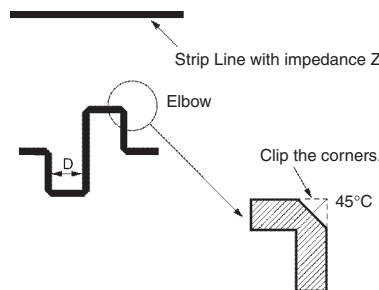

When the lines must curve, an elbow can be used as shown in the diagram. A distance (D) between the lines of approximately twice the line width is sufficient.

Relay Handling

When washing the product after soldering the Relay to a PCB, use a water-based solvent or alcohol-based solvent, and keep the solvent temperature to less than 40°C. Do not put the Relay in a cold cleaning bath immediately after soldering.

Examples of Mounting Designs

Since this example emphasizes reducing mounting costs, expensive mounting methods such as through-hole boards are not shown. If such methods are to be used, the characteristics must be studied carefully using the actual board configuration.

Using a Double-sided Paper Epoxy Board

When double-sided paper epoxy boards are used, the dielectric constant will be approximately the same as that of glass epoxy boards ($\epsilon_r=4.8$).

The width of the Strip Lines for a board with $t=1.6$ mm is 2.7 mm for 50 Ω and 1.3 mm for 75 Ω . For a board with $t=1.0$ mm the width is 1.7 mm for 50 Ω and 0.8 mm for 75 Ω .

The following diagram shows an example pattern and the Micro Strip Lines connected to the contact terminals are formed with pattern widths derived from the description above. The width between the Micro Strip Lines and ground patterns are comparable to the Micro Strip Line width.

There are jumpers between the upper and lower patterns at the points marked with Xs in the diagram. Improved characteristics can be obtained with more jumper locations. This method yields isolation characteristics of 65 dB to 75 dB at 500 MHz and 50 dB at 900 MHz.

At this point in the diagram the component side is the entire ground pattern side, but set aside approximately 2.0 mm \times 2.0 mm of the pattern for the contact terminals and coil terminals.

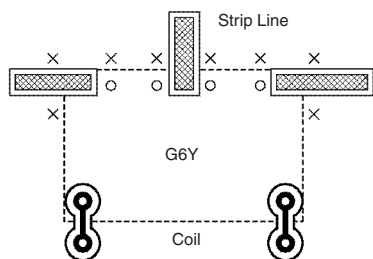

Using a Single-sided Board

When a single-sided board is used, isolation characteristics of only 60 dB to 70 dB at 200 MHz can be obtained. When high frequency bands are to be used with a single-sided board, a metal plate can be placed between the base and Relay and connected to the ground pattern.

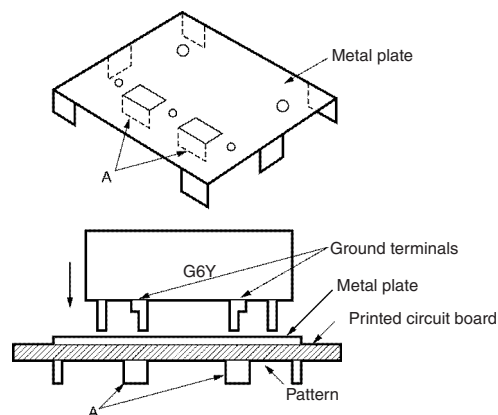

With this method a metal plate is placed between the Relay and base and connected to the pattern, as shown in the above diagram. The important point here is that 3 locations (the G6Y's ground terminal, the metal plate's bent tabs (A), and the ground pattern) are soldered together at the same time. This method combines an inexpensive single-sided board and inexpensive metal plate to yield the same characteristics as a double-sided board. Good characteristics are obtained by grounding the G6Y's ground terminal and metal plate in the same place.

The metal plate must be attached to the base as described here. From this point, the methods used for Strip Line design are the same as for the double-sided board.

Mounting Precautions

Be sure to securely attach the Relay's base surface to the board during installation. The isolation characteristics will be affected if the Relay lifts off the board.

As shown in the enlarged illustration of the cross-section of part A, the G6Y is designed to ensure better high-frequency characteristics if the stand-off part of the G6Y is in contact with the ground pattern of the PCB. Therefore, the ground terminal and stand-off part are electrically connected internally.

Should the through hole electrically connected to the contact terminal come in contact with the stand-off part, the contact will be short-circuited with the ground, which may cause an accident.

As a preventive measure, keep at least a distance of 0.3 mm between the stand-off part and the through hole or land.

For example, if the terminal hole on the PCB is 1 mm in diameter and the length B shown in the illustration is 1.4 mm, a distance of 0.3 mm or more will be provided between the through hole and stand-off part.

PCB Mounting

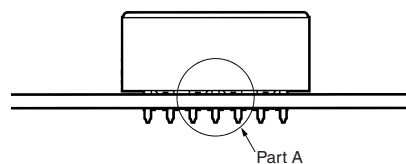

Cross-section of Part A

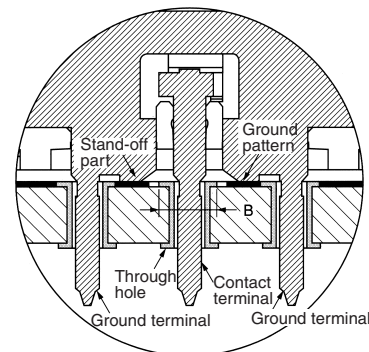

All sales are subject to Omron Electronic Components LLC standard terms and conditions of sale, which can be found at http://www.components.omron.com/components/web/webfiles.nsf/sales_terms.html

ALL DIMENSIONS SHOWN ARE IN MILLIMETERS.

To convert millimeters into inches, multiply by 0.03937. To convert grams into ounces, multiply by 0.03527.

OMRON[®]

**OMRON ELECTRONIC
COMPONENTS LLC**

55 E. Commerce Drive, Suite B
Schaumburg, IL 60173

847-882-2288

OMRON ON-LINE

Global - <http://www.omron.com>

USA - <http://www.components.omron.com>