

Thermally-Enhanced High Power RF LDMOS FET 240 W, 28 V, 1930 – 1995 MHz

Description

The PXAC192908FV is a 240-watt LDMOS FET with an asymmetrical design intended for use in multi-standard cellular power amplifier applications in the 1930 to 1995 MHz frequency band. Features include dual-path design, high gain and thermally-enhanced package with earless flanges. Manufactured with Infineon's advanced LDMOS process, this device provides excellent thermal performance and superior reliability.

PXAC192908FV
Package H-37275G-6/2

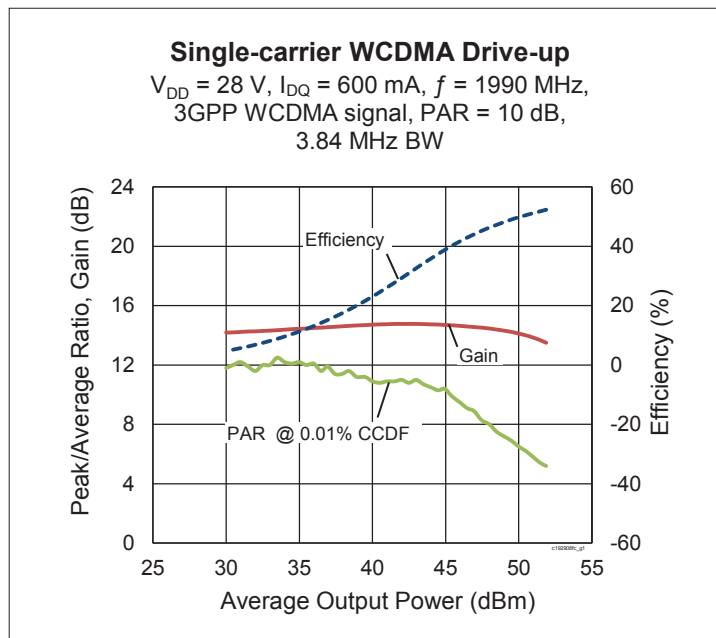
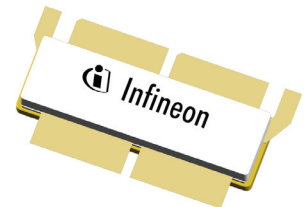

Features

- Broadband internal input and output matching
- Asymmetric Doherty design
 - Main: $P_{1dB} = 120\text{ W Typ}$
 - Peak: $P_{1dB} = 220\text{ W Typ}$
- Typical Pulsed CW performance, 1990 MHz, 28 V, combined outputs
 - Output power at $P_{1dB} = 240\text{ W}$
 - Efficiency = 54%
 - Gain = 14 dB
- Capable of handling 10:1 VSWR @ 28 V, 240 W (CW) output power
- Integrated ESD protection
- Human Body Model, Class 2 (per ANSI/ESDA/ JEDEC JS-001)
- Low thermal resistance
- Pb-free and RoHS compliant

RF Characteristics

Single-carrier WCDMA Specifications (tested in Infineon Doherty test fixture)

$V_{DD} = 28\text{ V}$, $I_{DQ} = 0.6\text{ A}$, $V_{GS(PEAK)} = 0.55\text{ V}$, $P_{OUT} = 70\text{ W avg}$, $f_1 = 1990\text{ MHz}$, 3GPP signal, channel bandwidth = 3.84 MHz, peak/average = 10 dB @ 0.01% CCDF

Characteristic	Symbol	Min	Typ	Max	Unit
Gain	G_{ps}	13	14	—	dB
Drain Efficiency	η_D	45	49	—	%
Adjacent Channel Power Ratio	ACPR	—	-28	-25	dBc

All published data at $T_{CASE} = 25^\circ\text{C}$ unless otherwise indicated

ESD: Electrostatic discharge sensitive device—observe handling precautions!

DC Characteristics (each side)

Characteristic	Conditions	Symbol	Min	Typ	Max	Unit
Drain-Source Breakdown Voltage	$V_{GS} = 0\text{ V}$, $I_{DS} = 10\text{ mA}$	$V_{(BR)DSS}$	65	—	—	V
Drain Leakage Current	$V_{DS} = 28\text{ V}$, $V_{GS} = 0\text{ V}$	I_{DSS}	—	—	1	μA
	$V_{DS} = 63\text{ V}$, $V_{GS} = 0\text{ V}$	I_{DSS}	—	—	10	μA
On-State Resistance (main)	$V_{GS} = 10\text{ V}$, $V_{DS} = 0.1\text{ V}$	$R_{DS(on)}$	—	0.11	—	Ω
	(peak) $V_{GS} = 10\text{ V}$, $V_{DS} = 0.1\text{ V}$	$R_{DS(on)}$	—	0.06	—	Ω
Operating Gate Voltage (main)	$V_{DS} = 28\text{ V}$, $I_{DQ} = 0.6\text{ A}$	V_{GS}	2.5	2.65	2.75	V
	(peak) $V_{DS} = 28\text{ V}$, $I_{DQ} = 0\text{ A}$	V_{GS}	0.45	0.55	0.75	V
Gate Leakage Current	$V_{GS} = 10\text{ V}$, $V_{DS} = 0\text{ V}$	I_{GSS}	—	—	1	μA

Maximum Ratings

Parameter	Symbol	Value	Unit
Drain-Source Voltage	V_{DSS}	65	V
Gate-Source Voltage	V_{GS}	-6 to +10	V
Operating Voltage	V_{DD}	0 to +32	V
Junction Temperature	T_J	225	$^{\circ}\text{C}$
Storage Temperature Range	T_{STG}	-65 to +150	$^{\circ}\text{C}$
Thermal Resistance (Doherty, $T_{CASE} = 70^{\circ}\text{C}$, 200 W CW, 1960 MHz, 28V, $I_{DQ}(\text{main}) = 600\text{ mA}$, $V_{GS}(\text{peak}) = 0.55\text{ V}$)	$R_{\theta JC}$	0.32	$^{\circ}\text{C/W}$

Ordering Information

Type and Version	Order Code	Package Description	Shipping
PXAC192908FV V1 R0	PXAC192908FVV1R0XTMA1	H-37275G-6/2, earless flange	Tape & Reel, 50 pcs
PXAC192908FV V1 R250	PXAC192908FVV1R250XTMA1	H-37275G-6/2, earless flange	Tape & Reel, 250 pcs

Typical Performance (data taken in a production Doherty test fixture)

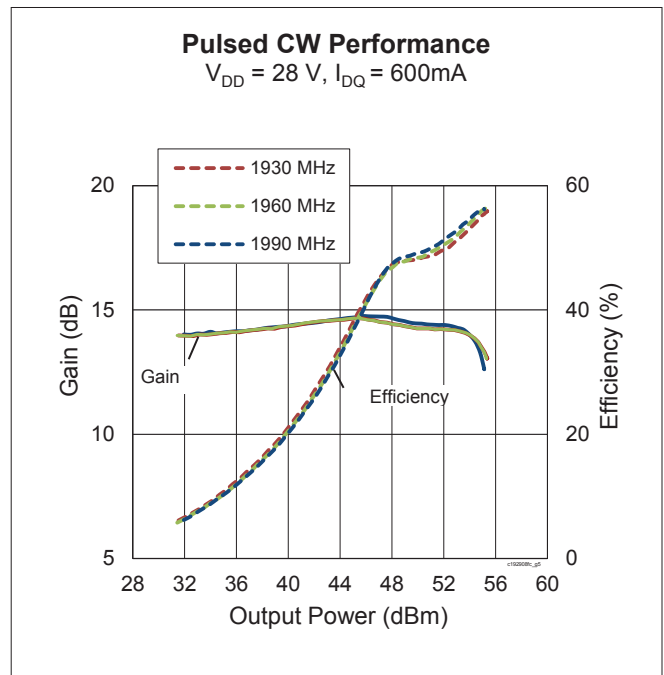
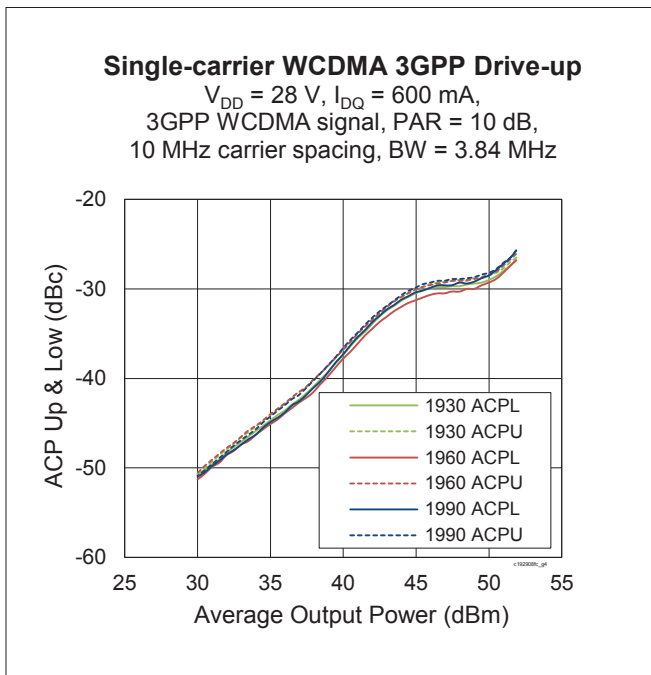
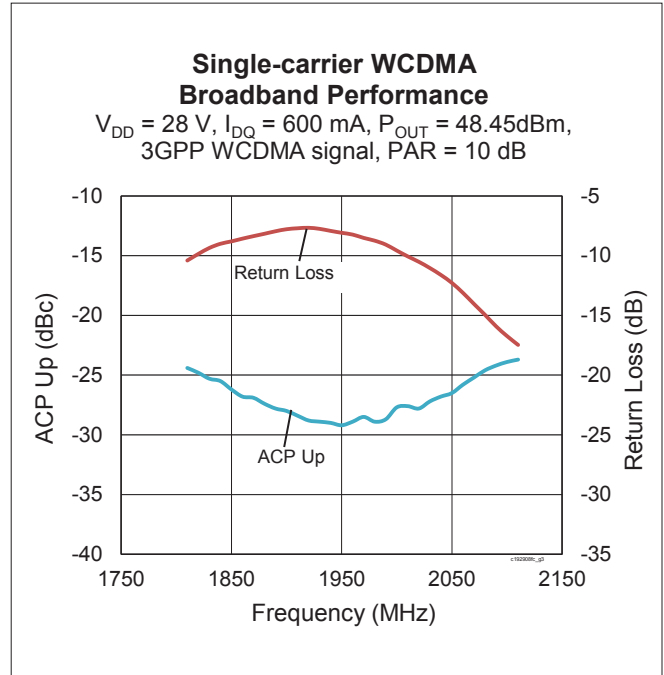
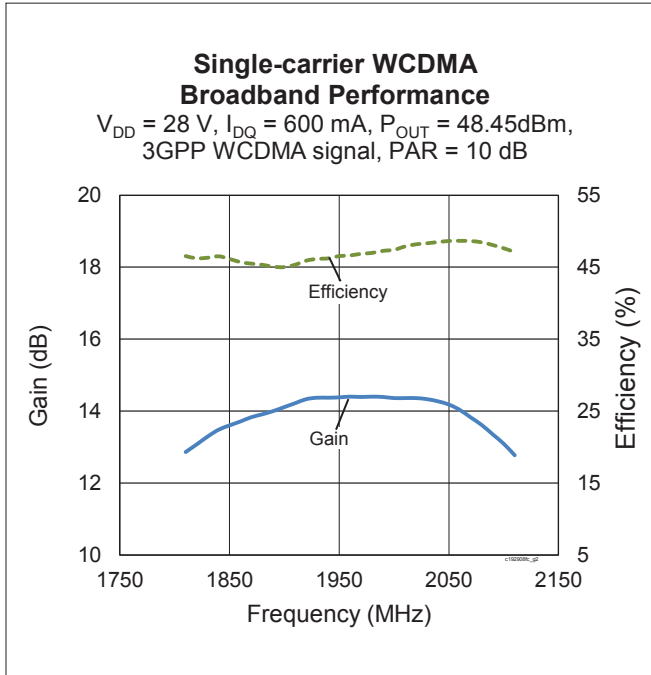

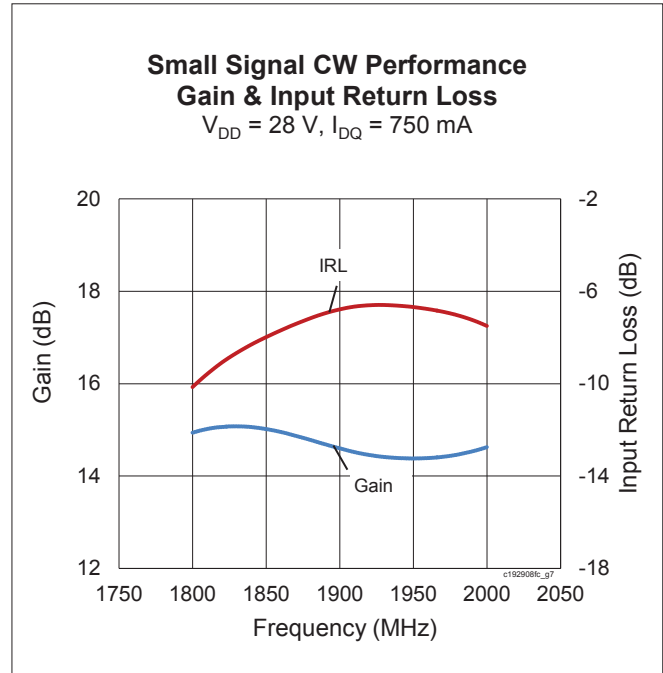
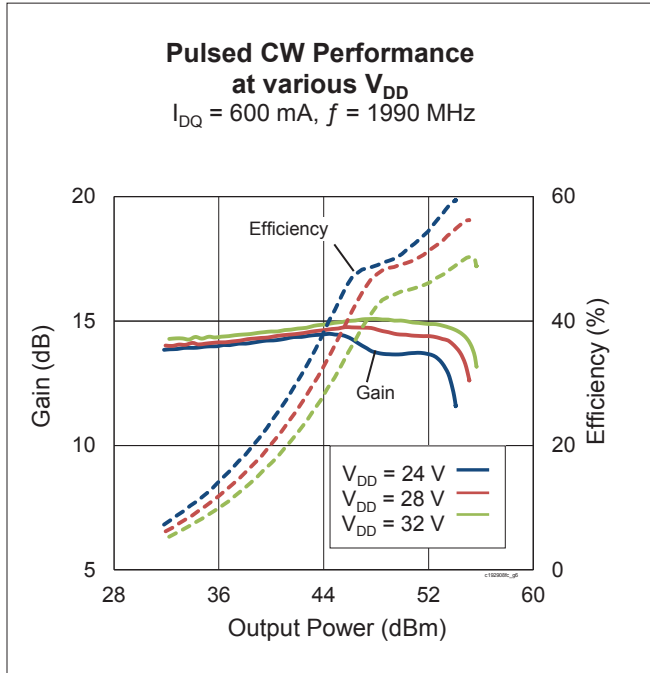
Typical Performance (cont.)

Load Pull Performance
Main Side Load Pull Performance – Pulsed CW signal: 16 μs , 10% duty cycle, $V_{DD} = 28 \text{ V}$, $I_{DQ} = 600 \text{ mA}$

Freq [MHz]	Z_s [Ω]	P1dB									
		Max Output Power					Max PAE				
		Z_L [Ω]	Gain [dB]	P_{OUT} [dBm]	P_{OUT} [W]	PAE [%]	Z_L [Ω]	Gain [dB]	P_{OUT} [dBm]	P_{OUT} [W]	PAE [%]
1930	8.0 – j11.0	2.1 – j4.7	18.0	51.10	128.8	50.4	3.6 – j2.7	20.2	50.12	102.8	62.5
1960	11.9 – j11.9	2.1 – j4.7	18.2	51.10	128.8	51.0	3.6 – j2.9	20.2	50.08	101.9	61.6
1990	18.0 – j10.4	2.1 – j4.8	18.3	50.91	123.3	49.7	3.63 – j2.6	20.5	49.78	95.1	61.3

Peak Side Load Pull Performance – Pulsed CW signal: 16 μs , 10% duty cycle, $V_{DD} = 28 \text{ V}$, $I_{DQ} = 90 \text{ mA}$

Freq [MHz]	Z_s [Ω]	P1dB									
		Max Output Power					Max PAE				
		Z_L [Ω]	Gain [dB]	P_{OUT} [dBm]	P_{OUT} [W]	PAE [%]	Z_L [Ω]	Gain [dB]	P_{OUT} [dBm]	P_{OUT} [W]	PAE [%]
1930	1.7 – j5.3	5.3 – j3.8	18.0	54.24	265.5	55.6	2.9 – j2.0	19.6	53.04	201.4	66.3
1960	2.0 – j5.8	5.3 – j3.7	18.4	54.16	260.6	55.7	2.9 – j2.2	20.1	52.90	195.0	66.0
1990	3.2 – j6.9	6.3 – j2.8	18.7	54.08	255.9	54.7	2.9 – j2.2	20.3	52.88	194.1	65.0

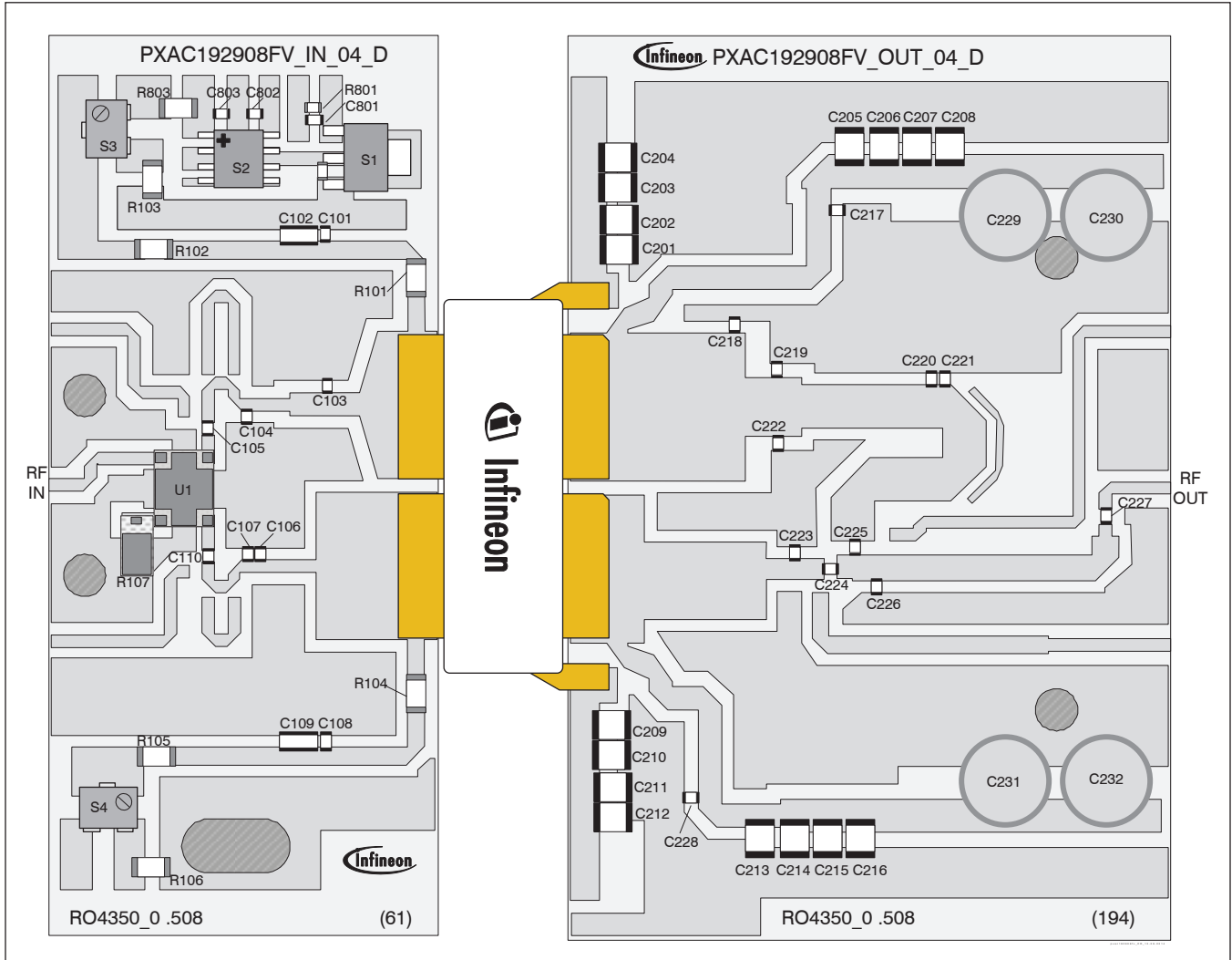
Reference Circuit , 1930 – 1990 MHz



Reference circuit assembly diagram (not to scale)

Reference Circuit (cont.)

Reference Circuit Assembly

DUT	PXAC192908FV V1
Test Fixture Part No.	LTA/PXAC192908FV V1
PCB	Rogers 4350, 0.508 mm [0.020"] thick, 2 oz. copper, $\epsilon_r = 3.66$, $f = 1930 - 1990$ MHz
Find Gerber files for this test fixture on the Infineon Web site at http://www.infineon.com/rfpower	

Components Information

Component	Description	Suggested Manufacturer	P/N
Input			
C101, C108, C105	Capacitor, 18 pF	ATC	ATC600F180JT250X
C102, C109	Capacitor, 10 μ F	Murata	LLL31BC70G106MA01L
C103	Capacitor, 1 pF	ATC	ATC600F1R0CT250X
C104	Capacitor, 1.2 pF	ATC	ATC600A1R2CT250X
C106	Capacitor, 0.5 pF	ATC	ATC600F0R5CT250X
C107	Capacitor, 1.1 pF	ATC	ATC600F1R1CT250X
C801, C802, C803	Capacitor, 1000 pF	Panasonic Electronic Components	ECJ-1VB1H102K
R101, R104	Resistor, 5600 Ω	Panasonic Electronic Components	ERJ-8RQJ5R6V
R102, R105	Resistor, 1000 Ω	Panasonic Electronic Components	ERJ-8GEYJ102V
R103, R106	Resistor, 5.1 Ω	Panasonic Electronic Components	ERJ-8GEYJ5R1V
R107	Resistor, 50 Ω	Richardson	C16A50Z4
R801	Resistor, 1300 Ω	Panasonic Electronic Components	ERJ-3GEYJ132V
R802	Resistor, 1200 Ω	Panasonic Electronic Components	ERJ-3GEYJ122V
R803	Resistor, 5100 Ω	Panasonic Electronic Components	ERJ-8GEYJ512V
S1	Voltage Regulator	Texas Instruments	LM78L05ACM
S2	Transistor	Infineon Technologies	BCP56
S3, S4	Potentiometer, 2k Ω	Bourns Inc.	3224W-1-202E
U1	Hybrid coupler	Anaren	X3C19P1-04S
Output			
C201, C202, C203, C204, C205, C206, C207, C208, C209, C210, C211, C212, C213, C214, C215, C216	Capacitor, 10 μ F	Taiyo Yuden	UMK325C7106MM-T
C217, C224, C225, C227, C228	Capacitor, 18 pF	ATC	ATC600F180JT250X
C218	Capacitor, 0.5 pF	ATC	ATC600F0R5CT250X
C219	Capacitor, 1.8 pF	ATC	ATC600F1R8CT250X
C220	Capacitor, 0.8 pF	ATC	ATC600F0R8CT250X
C221	Capacitor, 0.4 pF	ATC	ATC600F0R4CT250X
C222, C226	Capacitor, 0.2 pF	ATC	ATC600F0R2CT250X
C223	Capacitor, 1.0 pF	ATC	ATC600F1R0CT250X
C229, C230, C231, 232	Capacitor, 220 μ F	Panasonic Electronic Components	EEE-FP1V221AP

Pinout Diagram (top view)

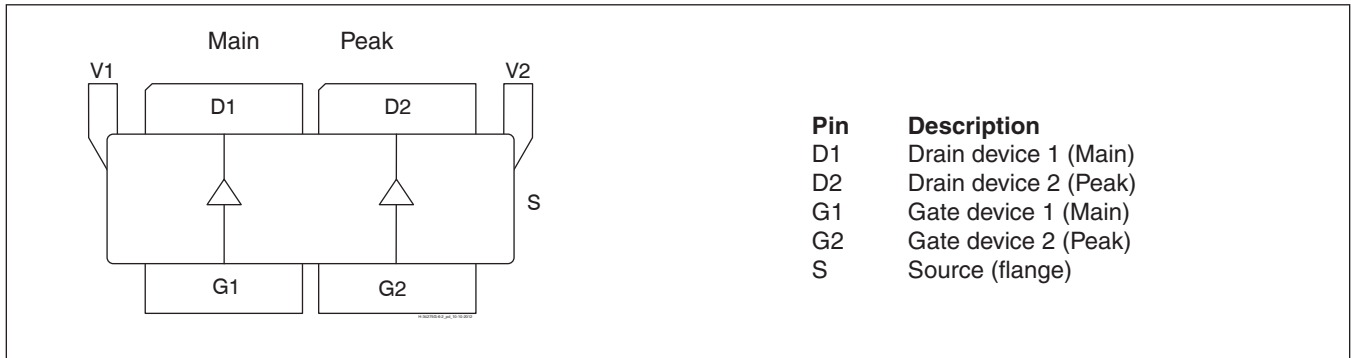

Lead connections for PXAC192908FV

Package Outline Specifications

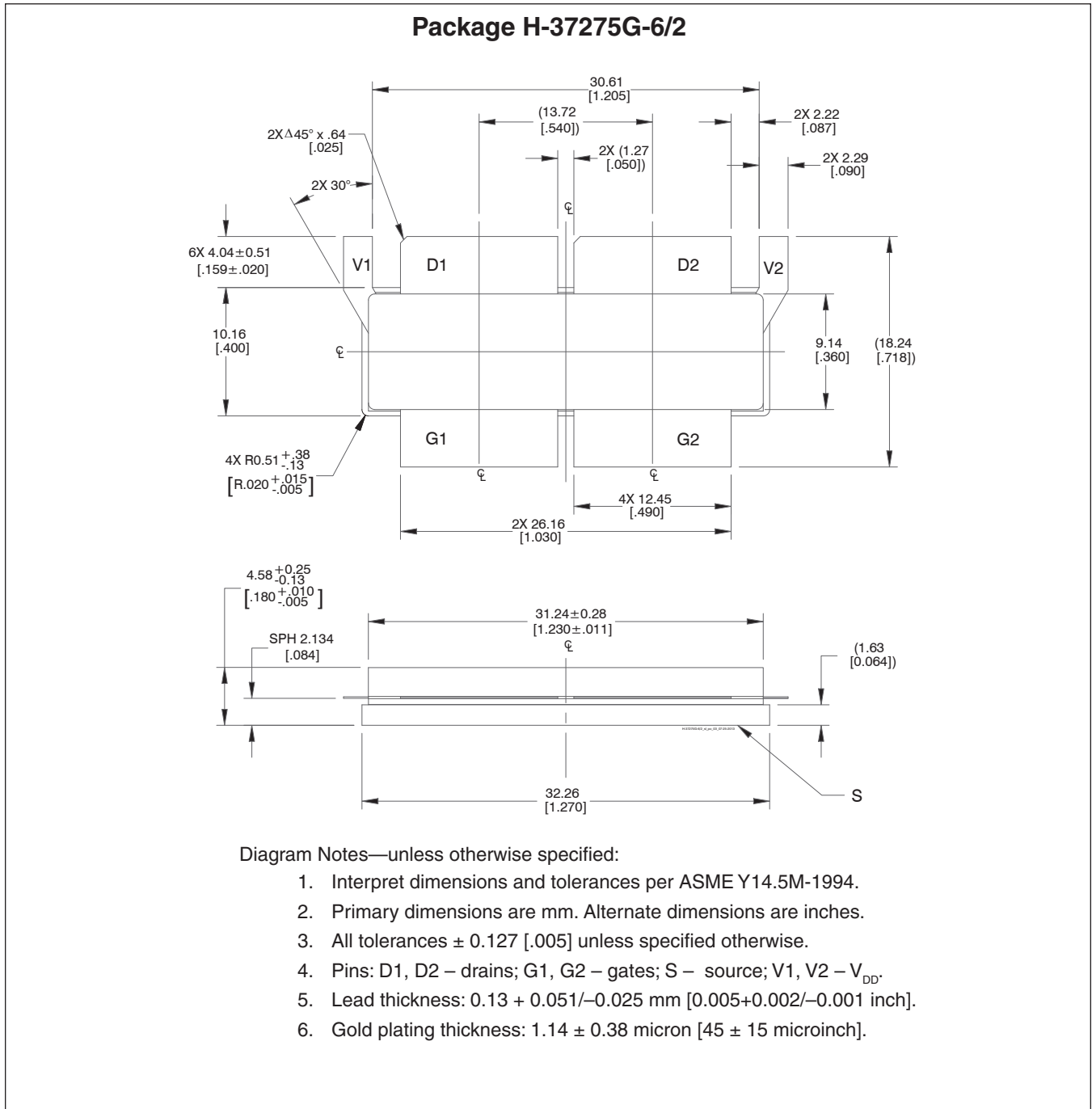

Find the latest and most complete information about products and packaging at the Infineon Internet page
<http://www.infineon.com/rpower>

Revision History

Revision	Date	Data Sheet Type	Page	Subjects (major changes since last revision)
01	2014-06-24	Advance	All	Data Sheet reflects advance specification for product development
01.1	2014-08-27	Advance	2	Updated main and peak side of pinout diagram, added thermal resistance
01.2	2014-09-24	Advance	2	Updated thermal resistance
02	2014-12-08	Production	All	Data Sheet reflects released product specification
02.1	2015-01-13	Production	4	Revised IDQ on main side of Load Pull Performance
02.2	2015-07-14	Production	1	Updated P1dB main & peak in Features
02.3	2016-06-17	Production	2	Updated ordering information to include R0

We Listen to Your Comments

Any information within this document that you feel is wrong, unclear or missing at all?
 Your feedback will help us to continuously improve the quality of this document.
 Please send your proposal (including a reference to this document) to:

highpowerRF@infineon.com

To request other information, contact us at:
 +1 877 465 3667 (1-877-GO-LDMOS) USA
 or +1 408 776 0600 International

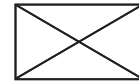

Edition 2016-06-17

Published by
Infineon Technologies AG
 85579 Neubiberg, Germany

© 2014 Infineon Technologies AG
 All Rights Reserved.

Legal Disclaimer

The information given in this document shall in no event be regarded as a guarantee of conditions or characteristics. With respect to any examples or hints given herein, any typical values stated herein and/or any information regarding the application of the device, Infineon Technologies hereby disclaims any and all warranties and liabilities of any kind, including without limitation, warranties of non-infringement of intellectual property rights of any third party.

Information

For further information on technology, delivery terms and conditions and prices, please contact the nearest Infineon Technologies Office (www.infineon.com/rfpower).

Warnings

Due to technical requirements, components may contain dangerous substances. For information on the types in question, please contact the nearest Infineon Technologies Office.

Infineon Technologies components may be used in life-support devices or systems only with the express written approval of Infineon Technologies, if a failure of such components can reasonably be expected to cause the failure of that life-support device or system or to affect the safety or effectiveness of that device or system. Life support devices or systems are intended to be implanted in the human body or to support and/or maintain and sustain and/or protect human life. If they fail, it is reasonable to assume that the health of the user or other persons may be endangered.