

Double channel high side driver

Features

Type	$R_{DS(on)}$	I_{lim}	V_{CC}
VND600PEP-E	30m Ω ⁽¹⁾	25A	36V

1. Per each channel

- DC short circuit current: 25A
- CMOS compatible inputs
- Proportional load current sense
- Undervoltage and overvoltage shutdown
- Overvoltage clamp
- Thermal shutdown
- Current limitation
- Very low standby power dissipation
- Protection against: loss of ground and loss of V_{CC}
- Reverse battery protection (see [Application schematic on page 13](#))
- In compliance with the 2002/95/ec european directive



Description

The VND600PEP-E is a monolithic device made using STMicroelectronics VIPower™ M0-3 technology. It is intended for driving resistive or inductive loads with one side connected to ground. Active V_{CC} pin voltage clamp protects the device against low energy spikes (see ISO7637 transient compatibility table).

This device has two channels in high side configuration; each channel has an analog sense output on which the sensing current is proportional (according to a known ratio) to the corresponding load current. Built-in thermal shutdown and outputs current limitation protect the chip from over temperature and short circuit. Device turns off in case of ground pin disconnection.

Table 1. Device summary

Package	Order codes	
	Tube	Tape and reel
PowerSSO-24	VND600PEP-E	VND600PEPTR-E

Contents

1	Block diagram and pin description	5
2	Electrical specifications	6
2.1	Absolute maximum ratings	6
2.2	Thermal data	7
2.3	Electrical characteristics	7
3	Application information	13
3.1	GND protection network against reverse battery	13
3.1.1	Solution 1: resistor in the ground line (R_{GND} only)	13
3.1.2	Solution 2: a diode (D_{GND}) in the ground line	14
3.2	Load dump protection	14
3.3	Microcontroller I/Os protection	14
3.4	Electrical characteristics curves	16
4	Package and PC board thermal data	18
4.1	PowerSSO-24 thermal data	18
5	Package and packing information	22
5.1	ECOPACK [®] packages	22
5.2	PowerSSO-24 mechanical data	22
5.3	Packing information	24
6	Revision history	25

List of tables

Table 1.	Device summary	1
Table 2.	Suggested connections for unused and not connected pins	5
Table 3.	Absolute maximum ratings	6
Table 4.	Thermal data	7
Table 5.	Power	7
Table 6.	Switching ($V_{CC} = 13V$)	8
Table 7.	V_{CC} - output diode	8
Table 8.	Logic input (channels 1, 2)	8
Table 9.	Current sense ($9V \leq V_{CC} \leq 16V$)	9
Table 10.	Protections	10
Table 11.	Truth table (per channel)	11
Table 12.	Electrical transient requirements (part 1/3)	11
Table 13.	Electrical transient requirements (part 2/3)	11
Table 14.	Electrical transient requirements (part 3/3)	12
Table 15.	Thermal parameters	20
Table 16.	PowerSSO-24 mechanical data	22
Table 17.	Document revision history	25

List of figures

Figure 1.	Block diagram	5
Figure 2.	Configuration diagram (top view)	5
Figure 3.	Current and voltage conventions	6
Figure 4.	Switching characteristics (resistive load $R_L=2.6$)	10
Figure 5.	Waveforms	12
Figure 6.	Application schematic	13
Figure 7.	I_{OUT}/I_{SENSE} versus I_{OUT}	15
Figure 8.	Off-state output current	16
Figure 9.	High level input current	16
Figure 10.	Input clamp voltage	16
Figure 11.	Input high level voltage	16
Figure 12.	Input low level voltage	16
Figure 13.	Input hysteresis voltage	16
Figure 14.	Overshoot shutdown	17
Figure 15.	I_{LIM} vs T_{case}	17
Figure 16.	Turn-on voltage slope	17
Figure 17.	Turn-off voltage slope	17
Figure 18.	On-state resistance vs T_{case}	17
Figure 19.	On-state resistance vs V_{CC}	17
Figure 20.	PowerSSO-24 PC board	18
Figure 21.	$R_{thj-amb}$ vs PCB copper area in open box free air condition	18
Figure 22.	Maximum turn-off current versus load inductance	19
Figure 23.	Demagnetization	19
Figure 24.	PowerSSO-24 thermal impedance junction ambient single pulse	20
Figure 25.	Thermal fitting model of a double channel HSD in PowerSSO-24	20
Figure 26.	PowerSSO-24 package dimensions	23
Figure 27.	PowerSSO-24 tube shipment (no suffix)	24
Figure 28.	PowerSSO-24 tape and reel shipment (suffix "TR")	24

1 Block diagram and pin description

Figure 1. Block diagram

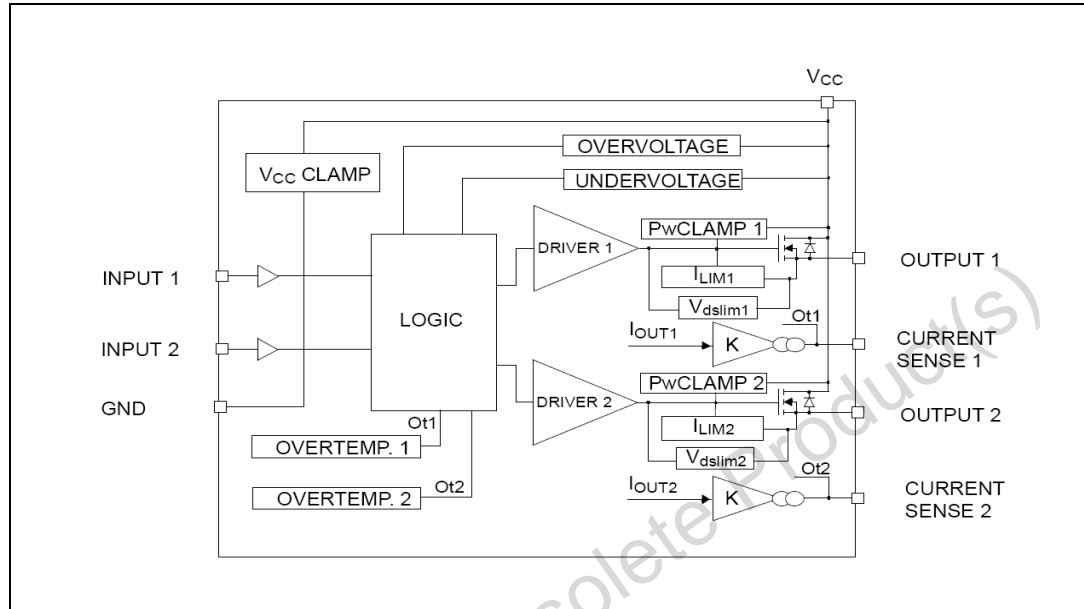

Figure 2. Configuration diagram (top view)

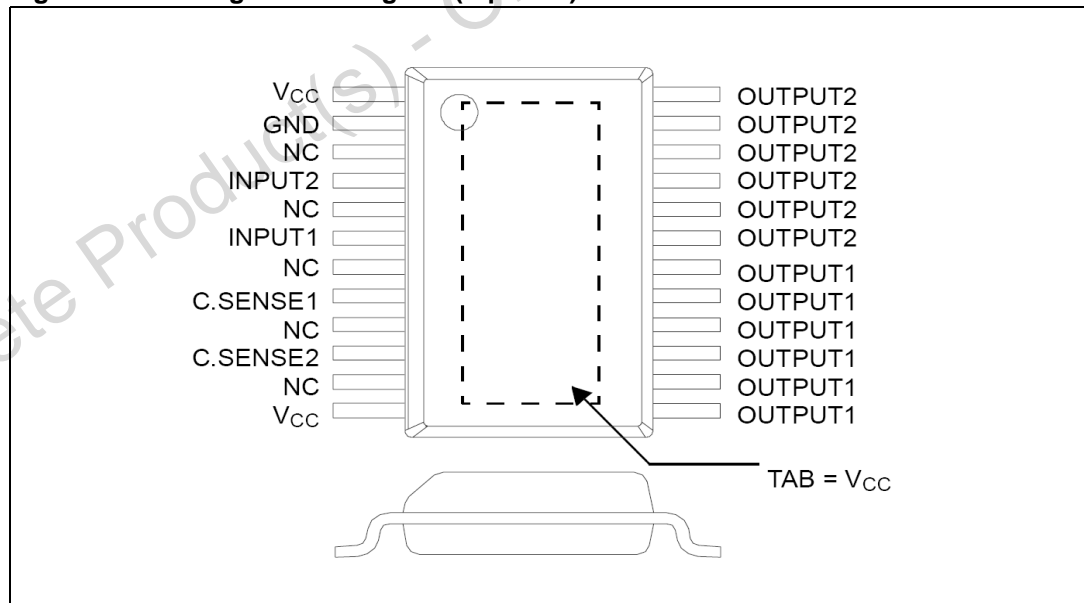
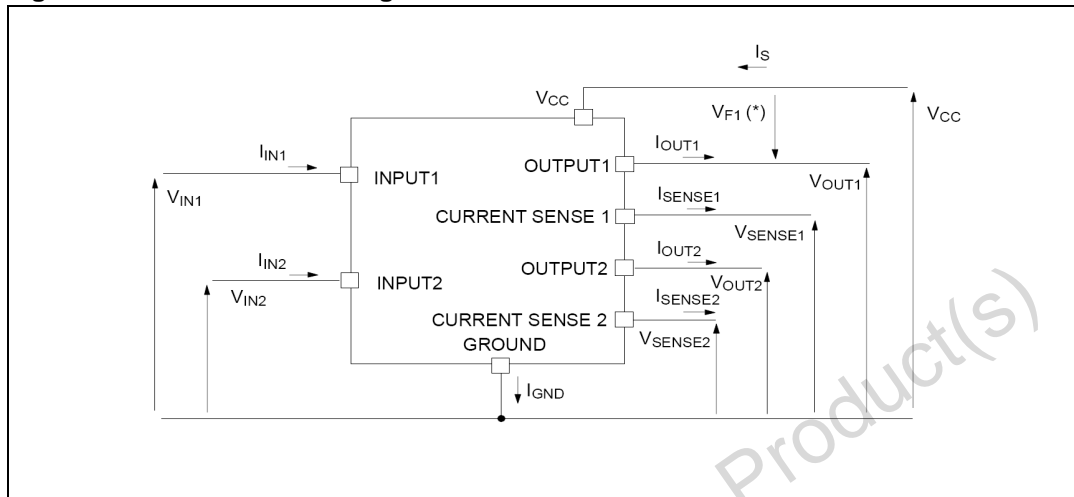

Table 2. Suggested connections for unused and not connected pins

Connection / pin	Current sense	N.C.	Output	Input
Floating		X	X	X
To ground	Through 1 kΩ resistor	X	Not allowed	Through 10 kΩ resistor

2 Electrical specifications

Figure 3. Current and voltage conventions



Note: $V_{Fn} = V_{CCn} - V_{OUTn}$ during reverse battery condition.

2.1 Absolute maximum ratings

Stressing the device above the rating listed in the “Absolute maximum ratings” table may cause permanent damage to the device. These are stress ratings only and operation of the device at these or any other conditions above those indicated in the operating sections of this specification is not implied. Exposure to the conditions in table below for extended periods may affect device reliability. Refer also to the STMicroelectronics SURE Program and other relevant quality document.

Table 3. Absolute maximum ratings

Symbol	Parameter	Value	Unit
V_{CC}	DC supply voltage	41	V
$-V_{CC}$	Reverse supply voltage	-0.3	V
$-I_{GND}$	DC reverse ground pin current	-200	mA
I_{OUT}	Output current	Internally limited	A
I_R	Reverse output current	-21	A
I_{IN}	Input current	+/-10	mA
V_{CSENSE}	Current sense maximum voltage	-3	V
		+15	V

Table 3. Absolute maximum ratings (continued)

Symbol	Parameter	Value	Unit
V _{ESD}	Electrostatic discharge (human body model: R=1.5KΩ; C=100pF)		
	– Input	4000	V
	– Current sense	2000	V
	– Output	5000	V
	– V _{CC}	5000	V
E _{MAX}	Maximum switching energy (L=0.13mH; R _L =0Ω; V _{bat} =13.5V; T _{jstart} =150°C; I _L =40A)	146	mJ
P _{tot}	Power dissipation at T _c =25°C	96	W
T _j	Junction operating temperature	Internally limited	°C
T _c	Case operating temperature	-40 to 150	°C
T _{STG}	Storage temperature	-55 to 150	°C

2.2 Thermal data

Table 4. Thermal data

Symbol	Parameter	Value	Unit	
R _{thj-case} ⁽¹⁾	Thermal resistance junction-case (max)	1.8	°C/W	
R _{thj-case} ⁽²⁾	Thermal resistance junction-case (max)	1.3	°C/W	
R _{thj-amb}	Thermal resistance junction-ambient (max)	54 ⁽³⁾	39 ⁽⁴⁾	°C/W

- one channel ON
- two channels ON
- When mounted on a standard single-sided FR-4 board with 0.5cm² of Cu (at least 35μm thick).
- When mounted on a standard single-sided FR-4 board with 8cm² of Cu (at least 35μm thick).

2.3 Electrical characteristics

8V < V_{CC} < 36V; -40°C < T_j < 150°C unless otherwise specified.

Per each channel

Table 5. Power

Symbol	Parameter	Test conditions	Min.	Typ.	Max.	Unit
V _{CC} ⁽¹⁾	Operating supply voltage		5.5	13	36	V
V _{USD} ⁽¹⁾	Undervoltage shutdown		3	4	5.5	V
V _{OV} ⁽¹⁾	Overvoltage shutdown		36			V

Table 5. Power (continued)

Symbol	Parameter	Test conditions	Min.	Typ.	Max.	Unit
R _{ON}	On-state resistance	I _{OUT} =5A; T _j =25°C			30	mΩ
		I _{OUT} =5A; T _j =150°C			60	mΩ
		I _{OUT} =3A; V _{CC} =6V			100	mΩ
V _{clamp}	Clamp Voltage	I _{CC} =20mA ⁽²⁾	41	48	55	V
I _S ⁽¹⁾	Supply current	Off-state; V _{CC} =13V; V _{IN} =V _{OUT} =0V		12	40	μA
		Off-state; V _{CC} =13V; V _{IN} =V _{OUT} =0V; T _j =25°C		12	25	μA
		On-state; V _{IN} =5V; V _{CC} =13V; I _{OUT} =0A; R _{SENSE} =3.9kΩ				6
I _{L(off1)}	Off-state Output Current	V _{IN} =V _{OUT} =V _{SENSE} =0V	0		50	μA
I _{L(off3)}	Off-state Output Current	V _{IN} =V _{OUT} =V _{SENSE} =0V; V _{CC} =13V; T _j =125°C			5	μA
I _{L(off4)}	Off-state Output Current	V _{IN} =V _{OUT} =V _{SENSE} =0V; V _{CC} =13V; T _j =25°C			3	μA

1. Per device.

2. V_{clamp} and V_{OV} are correlated. Typical difference is 5V.

Table 6. Switching (V_{CC} =13V)

Symbol	Parameter	Test conditions	Min.	Typ.	Max.	Unit
t _{d(on)}	Turn-on delay time	R _L =2.6Ω (see Figure 4)	-	30	-	μs
t _{d(off)}	Turn-off delay time	R _L =2.6Ω (see Figure 4)	-	30	-	μs
(dV _{OUT} /dt) _{on}	Turn-on voltage slope	R _L =2.6Ω (see Figure 4)	-	See relative diagram	-	V/μs
(dV _{OUT} /dt) _{off}	Turn-off voltage slope	R _L =2.6Ω (see Figure 4)	-	See relative diagram	-	V/μs

Table 7. V_{CC} - output diode

Symbol	Parameter	Test conditions	Min.	Typ.	Max.	Unit
V _F	Forward on Voltage	-I _{OUT} =2.6A; T _j =150°C			0.6	V

Table 8. Logic input (channels 1, 2)

Symbol	Parameter	Test conditions	Min.	Typ.	Max.	Unit
V _{IL}	Input low level voltage				1.25	V
I _{IL}	Low level input current	V _{IN} =1.25V	20	65		μA
V _{IH}	Input high level voltage		3.25			V
I _{IH}	High level input current	V _{IN} =3.25V			10	μA

Table 8. Logic input (channels 1, 2) (continued)

Symbol	Parameter	Test conditions	Min.	Typ.	Max.	Unit
$V_{I(hyst)}$	Input hysteresis voltage		0.5			V
V_{ICL}	Input clamp voltage	$I_{IN}=1\text{mA}$ $I_{IN}=-1\text{mA}$	6	6.8 -0.7	8	V V

Table 9. Current sense ($9\text{V} \leq V_{CC} \leq 16\text{V}$)⁽¹⁾

Symbol	Parameter	Test conditions	Min.	Typ.	Max.	Unit
K_1	I_{OUT}/I_{SENSE}	I_{OUT1} or $I_{OUT2}=0.5\text{A}$; $V_{SENSE}=0.5\text{V}$; other channels open; $T_j=40^\circ\text{C} \dots 150^\circ\text{C}$	3300	4400	6000	
dK_1/K_1	Current sense ratio drift	I_{OUT1} or $I_{OUT2}=0.5\text{A}$; $V_{SENSE}=0.5\text{V}$; other channels open; $T_j=40^\circ\text{C} \dots 150^\circ\text{C}$	-10		+10	%
K_2	I_{OUT}/I_{SENSE}	I_{OUT1} or $I_{OUT2}=5\text{A}$; $V_{SENSE}=4\text{V}$; other channels open; $T_j=-40^\circ\text{C}$ $T_j=25^\circ\text{C} \dots 150^\circ\text{C}$	3800 3950	4400 4400	5400 5200	
dK_2/K_2	Current sense ratio drift	I_{OUT1} or $I_{OUT2}=5\text{A}$; $V_{SENSE}=4\text{V}$; other channels open; $T_j=-40^\circ\text{C} \dots 150^\circ\text{C}$	-6		+6	%
K_3	I_{OUT}/I_{SENSE}	I_{OUT1} or $I_{OUT2}=15\text{A}$; $V_{SENSE}=4\text{V}$; other channels open; $T_j=-40^\circ\text{C}$ $T_j=25^\circ\text{C} \dots 150^\circ\text{C}$	3800 3950	4400 4400	4900 4700	
dK_3/K_3	Current sense ratio drift	I_{OUT1} or $I_{OUT2}=15\text{A}$; $V_{SENSE}=4\text{V}$; other channels open; $T_j=-40^\circ\text{C} \dots 150^\circ\text{C}$	-6		+6	%
$V_{SENSE1,2}$	Max analog sense output voltage	$V_{CC}=5.5\text{V}$; $I_{OUT1,2}=2.5\text{A}$; $R_{SENSE}=10\text{k}\Omega$ $V_{CC}>8\text{V}$, $I_{OUT1,2}=5\text{A}$; $R_{SENSE}=10\text{k}\Omega$	2 4			V V
V_{SENSEH}	Analog sense output voltage in over temperature condition	$V_{CC}=13\text{V}$; $R_{SENSE}=3.9\text{k}\Omega$		5.5		V
$R_{VSENSEH}$	Analog sense output impedance in over temperature condition	$V_{CC}=13\text{V}$; $T_j > TTSD$; All channels open		400		Ω
t_{DSENSE}	Current sense delay response	to 90% I_{SENSE} ⁽²⁾			500	μs

1. See [Figure 7](#).

2. Current sense signal delay after positive input slope

Table 10. Protections (1)

Symbol	Parameter	Test conditions	Min.	Typ.	Max.	Unit
I_{lim}	DC short circuit current	$V_{CC}=13V$ $5.5V < V_{CC} < 36V$	25	40	70 70	A A
T_{TSD}	Thermal shutdown temperature		150	175	200	°C
T_R	Thermal reset temperature		135			°C
T_{HYST}	Thermal hysteresis		7	15		°C
V_{demag}	Turn-off output voltage clamp	$I_{OUT}=2A$; $V_{IN}=0V$; $L=6mH$	$V_{CC}-41$	$V_{CC}-48$	$V_{CC}-55$	V
V_{ON}	Output voltage drop limitation	$I_{OUT}=0.5A$; $T_j = -40°C \dots +150°C$		50		mV

- To ensure long term reliability under heavy overload or short circuit conditions, protection and related diagnostic signals must be used together with a proper software strategy. If the device is subjected to abnormal conditions, this software must limit the duration and number of activation cycles.

Figure 4. Switching characteristics (resistive load $R_L=2.6$)

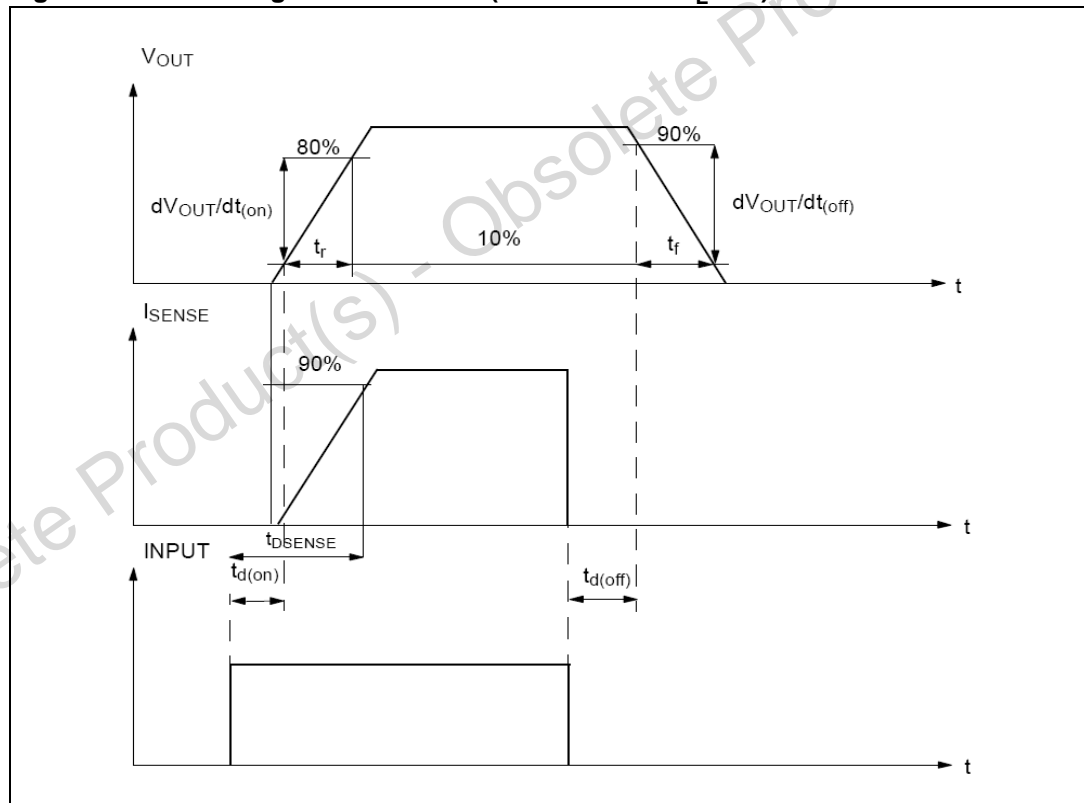

Table 11. Truth table (per channel)

Conditions	Input	Output	Sense
Normal operation	L	L	0
	H	H	Nominal
Over temperature	L	L	0
	H	L	V_{SENSEH}
Undervoltage	L	L	0
	H	L	0
Overvoltage	L	L	0
	H	L	0
Short circuit to GND	L	L	0 ($T_j < T_{TSD}$)
	H	L	0 ($T_j > T_{TSD}$)
	H	L	V_{SENSEH}
Short circuit to VXX	L	H	0
	H	H	< Nominal
Negative output voltage clamp	L	L	0

Table 12. Electrical transient requirements (part 1/3)

ISO T/R 7637/1 Test Pulse	Test levels				Delays and Impedance
	I	II	III	IV	
1	-25 V	-50 V	-75 V	-100 V	2 ms 10 Ω
2	+25 V	+50 V	+75 V	+100 V	0.2 ms 10 Ω
3a	-25 V	-50 V	-100 V	-150 V	0.1 μ s 50 Ω
3b	+25 V	+50 V	+75 V	+100 V	0.1 μ s 50 Ω
4	-4 V	-5 V	-6 V	-7 V	100 ms, 0.01 Ω
5	+26.5 V	+46.5 V	+66.5 V	+86.5 V	400 ms, 2 Ω

Table 13. Electrical transient requirements (part 2/3)

ISO T/R 7637/1 Test Pulse	Test levels results			
	I	II	III	IV
1	C	C	C	C
2	C	C	C	C
3a	C	C	C	C
3b	C	C	C	C
4	C	C	C	C
5	C	E	E	E

Table 14. Electrical transient requirements (part 3/3)

Class	Contents
C	All functions of the device are performed as designed after exposure to disturbance.
E	One or more functions of the device is not performed as designed after exposure to disturbance and cannot be returned to proper operation without replacing the device.

Figure 5. Waveforms

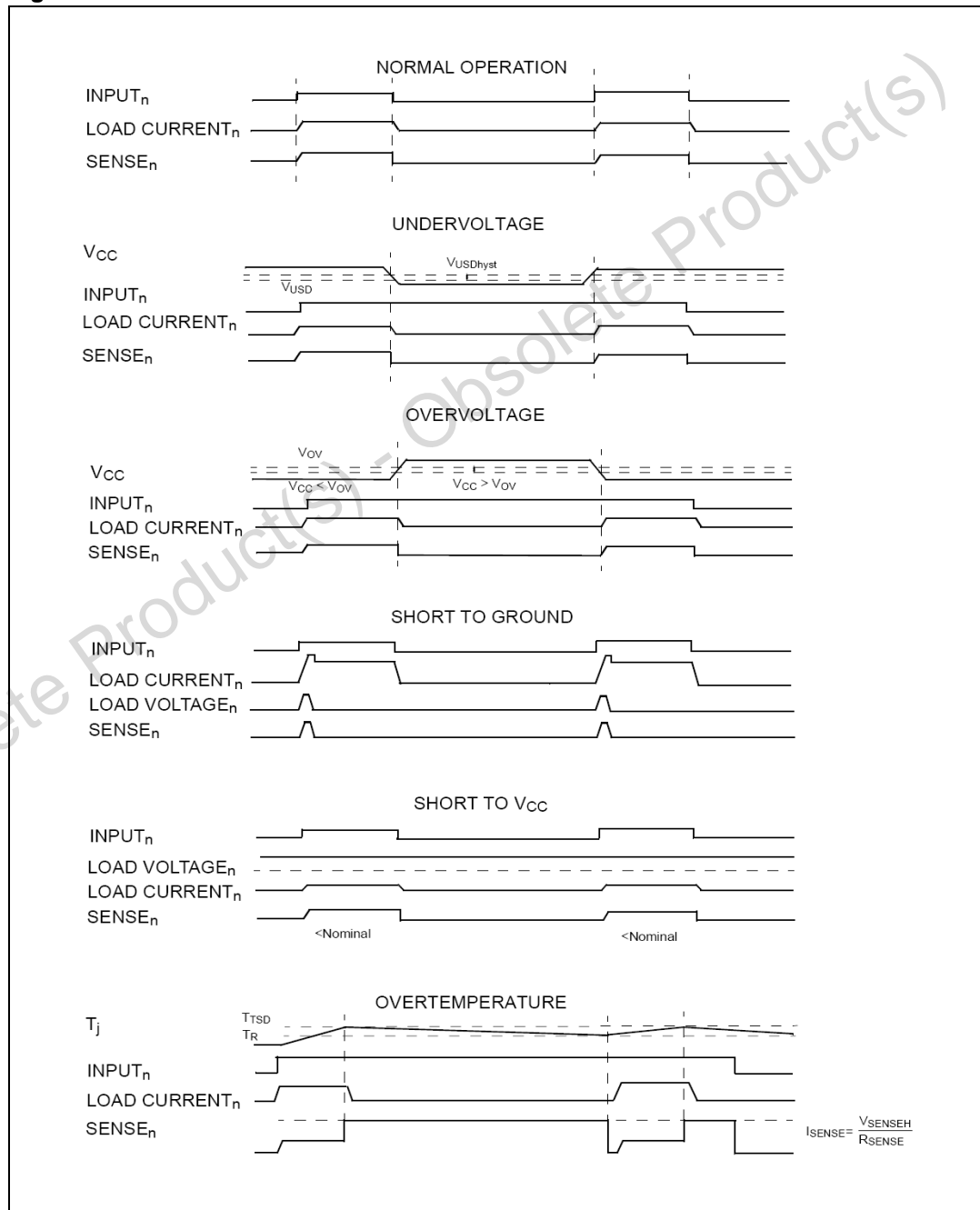

3 Application information

Figure 6. Application schematic

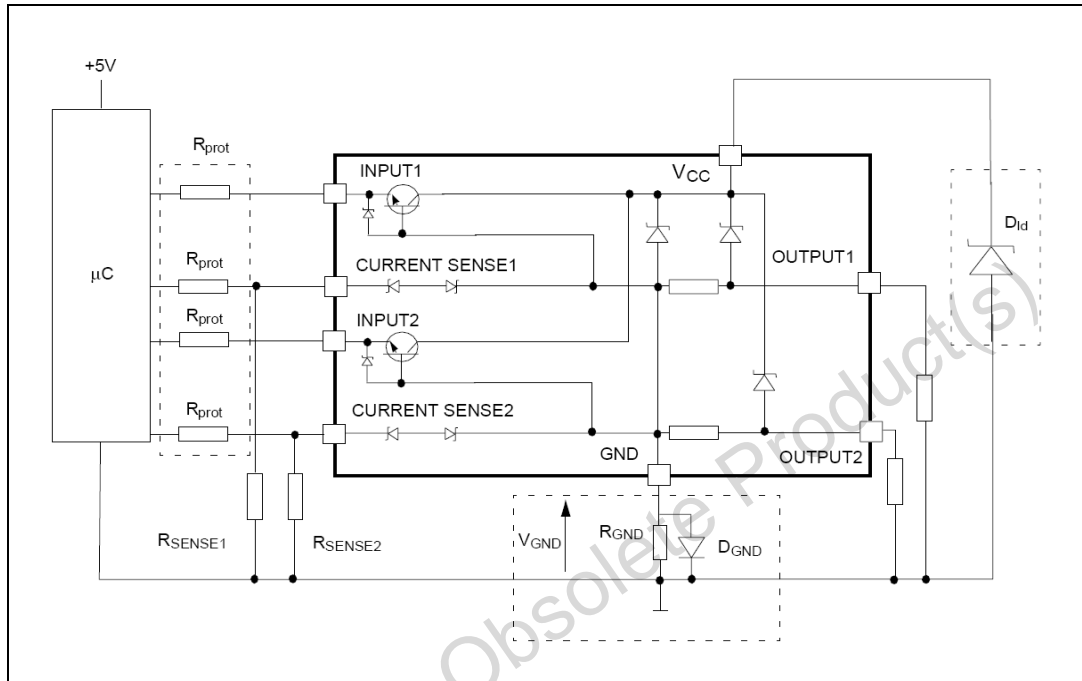

3.1 GND protection network against reverse battery

3.1.1 Solution 1: resistor in the ground line (R_{GND} only)

This solution can be used with any type of load.

The following is an indication on how to dimension the R_{GND} resistor.

1. $R_{GND} \leq 600\text{mV} / (I_{S(on)max})$
2. $R_{GND} \geq (V_{CC}) / (-I_{GND})$

where $-I_{GND}$ is the DC reverse ground pin current and can be found in the absolute maximum rating section of the device's datasheet. Power dissipation in R_{GND} (when $V_{CC} < 0$: during reverse battery situations) is:

$$P_D = (-V_{CC})^2 / R_{GND}$$

This resistor can be shared amongst several different HSD. Please note that the value of this resistor should be calculated with formula (1) where $I_{S(on)max}$ becomes the sum of the maximum on-state currents of the different devices.

Please note that if the microprocessor ground is not common with the device ground then the R_{GND} will produce a shift ($I_{S(on)max} * R_{GND}$) in the input thresholds and the status output values. This shift will vary depending on how many devices are on in the case of several high side drivers sharing the same R_{GND} .

If the calculated power dissipation leads to a large resistor or several devices have to share the same resistor then the ST suggests to utilize Solution 2 (see below).

3.1.2 Solution 2: a diode (D_{GND}) in the ground line

A resistor ($R_{GND}=1k\Omega$) should be inserted in parallel to D_{GND} if the device will be driving an inductive load.

This small signal diode can be safely shared amongst several different HSD. Also in this case, the presence of the ground network will produce a shift ($\approx 600mV$) in the input threshold and the status output values if the microprocessor ground is not common with the device ground. This shift will not vary if more than one HSD shares the same diode/resistor network.

Series resistor in input line is also required to prevent that, during battery voltage transient, the current exceeds the absolute maximum rating.

Safest configuration for unused input pin is to leave it unconnected, while unused sense pin has to be connected to ground pin.

3.2 Load dump protection

D_{ld} is necessary (voltage transient suppressor) if the load dump peak voltage exceeds V_{CC} max DC rating. The same applies if the device will be subject to transients on the V_{CC} line that are greater than the ones shown in the ISO T/R 7637/1 table.

3.3 Microcontroller I/Os protection

If a ground protection network is used and negative transients are present on the V_{CC} line, the control pins will be pulled negative. ST suggests to insert a resistor (R_{prot}) in line to prevent the μC I/Os pins to latch-up.

The value of these resistors is a compromise between the leakage current of μC and the current required by the HSD I/Os (input levels compatibility) with the latch-up limit of μC I/Os.

$$-V_{CCpeak}/I_{latchup} \leq R_{prot} \leq (V_{OH\mu C} - V_{IH} - V_{GND}) / I_{IHmax}$$

Calculation example:

$$\text{For } V_{CCpeak} = -100V \text{ and } I_{latchup} \geq 20mA; V_{OH\mu C} \geq 4.5V$$

$$5k\Omega \leq R_{prot} \leq 65k\Omega.$$

Recommended R_{prot} value is $10k\Omega$.

Figure 7. I_{OUT}/I_{SENSE} versus I_{OUT}

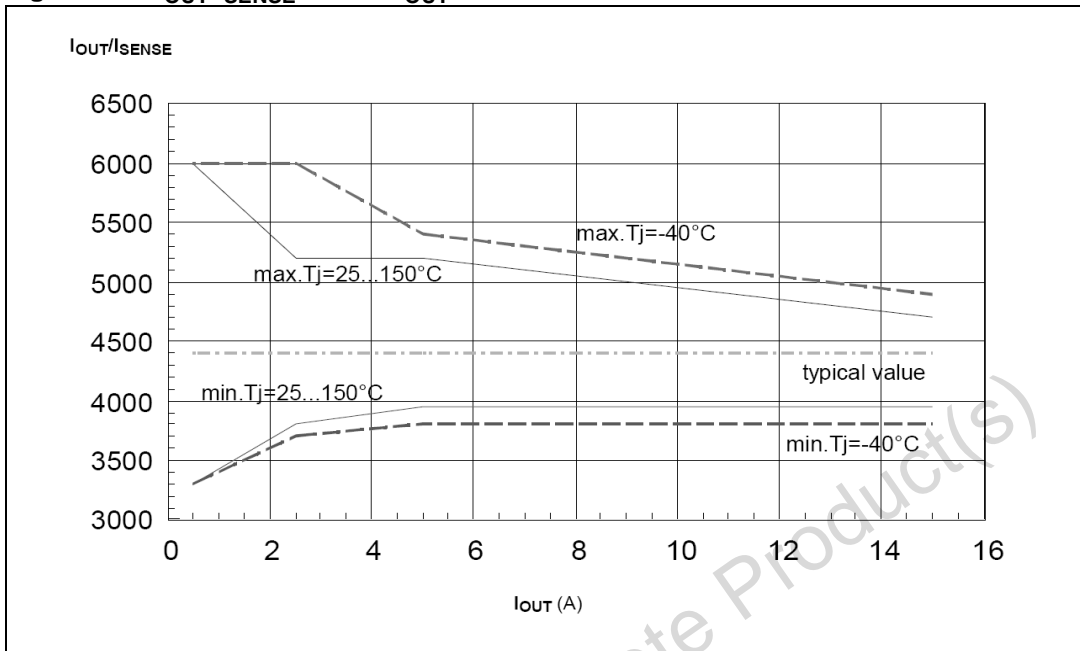

Obsolete Product(s) - Obsolete Product(s)

3.4 Electrical characteristics curves

Figure 8. Off-state output current

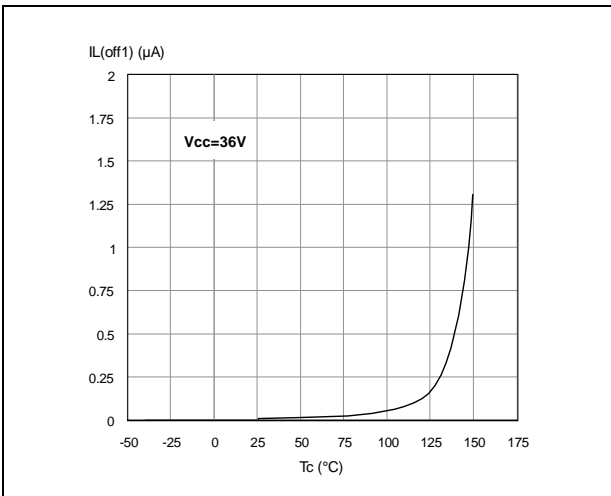

Figure 9. High level input current

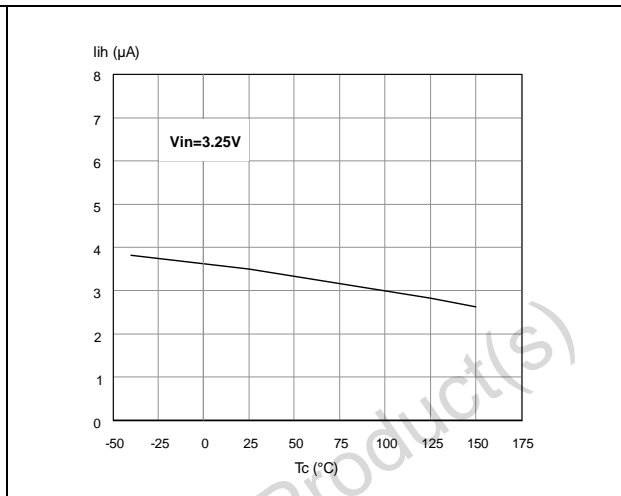

Figure 10. Input clamp voltage

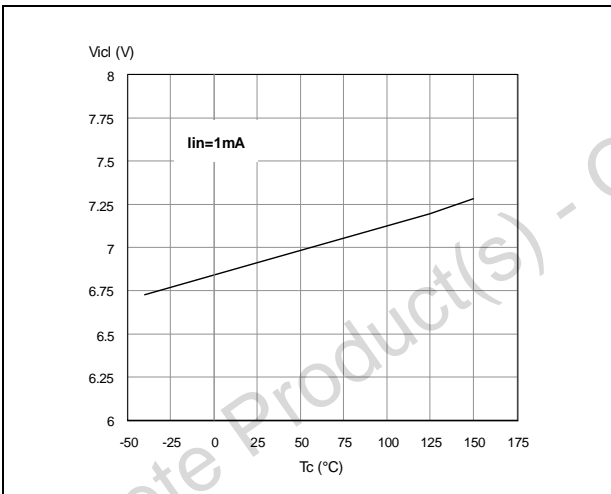

Figure 11. Input high level voltage

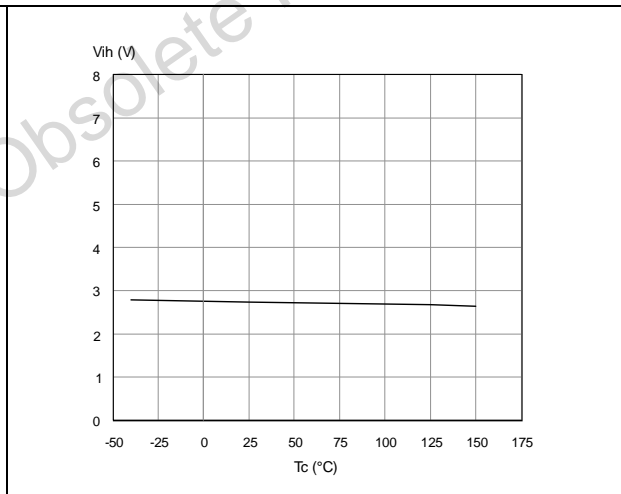

Figure 12. Input low level voltage

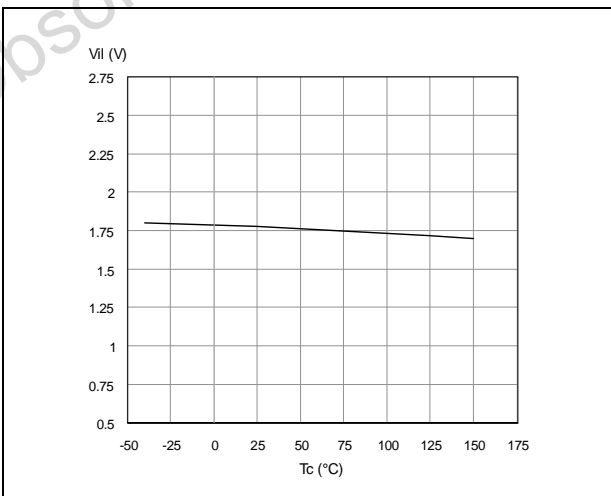

Figure 13. Input hysteresis voltage

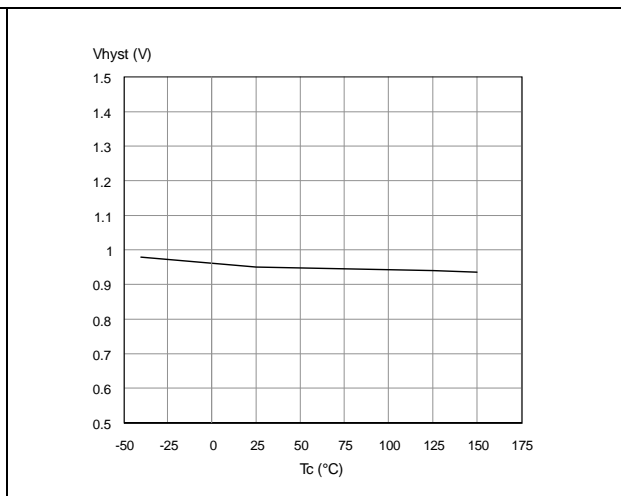

Figure 14. Overvoltage shutdown

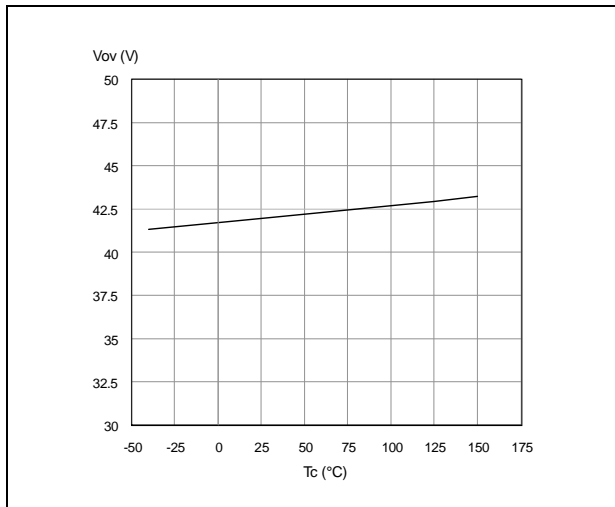

Figure 15. I_{LIM} vs T_{case}

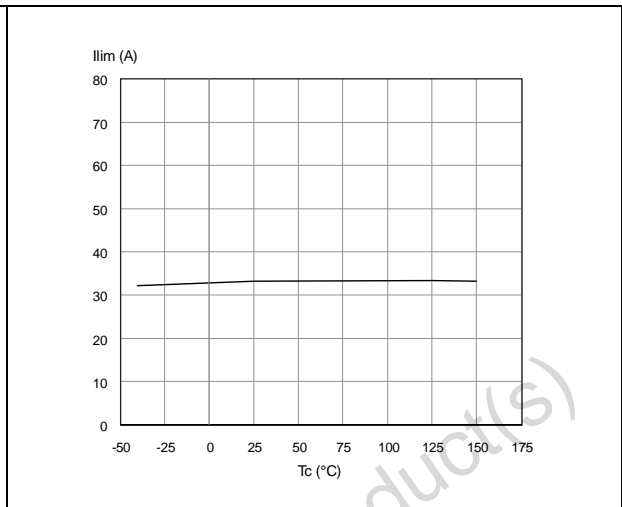

Figure 16. Turn-on voltage slope

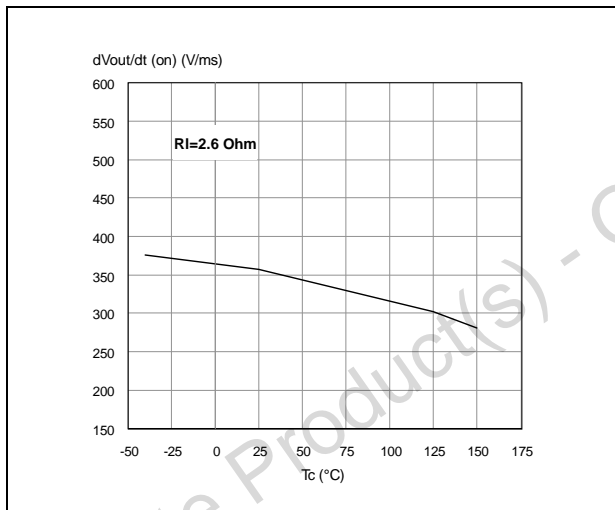

Figure 17. Turn-off voltage slope

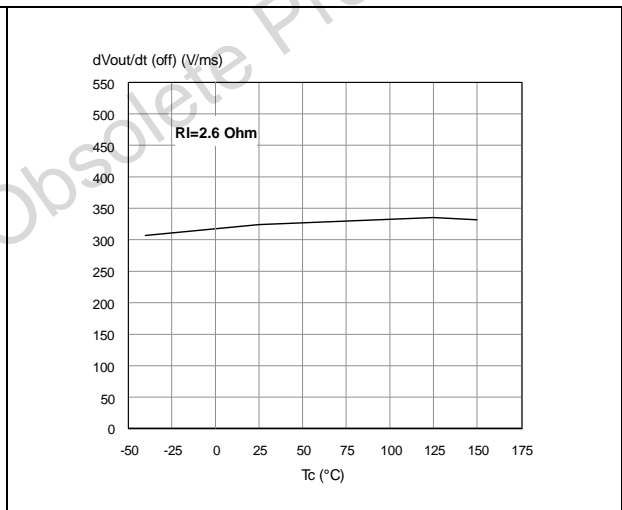

Figure 18. On-state resistance vs T_{case}

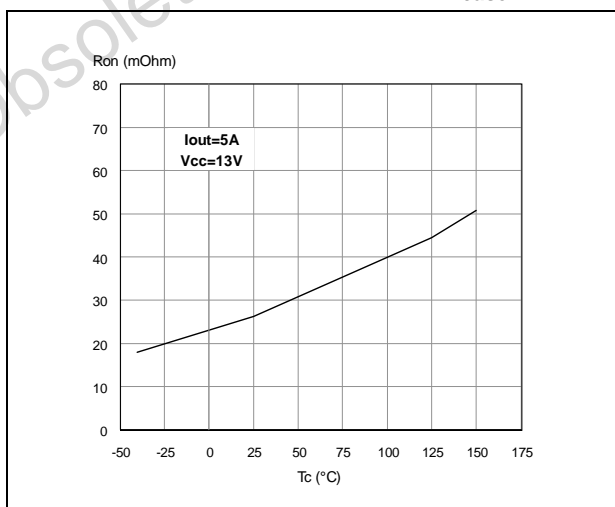
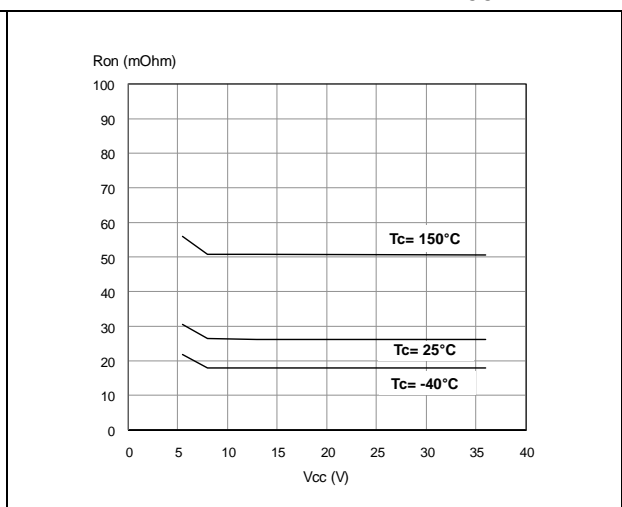

Figure 19. On-state resistance vs V_{CC}



4 Package and PC board thermal data

4.1 PowerSSO-24 thermal data

Figure 20. PowerSSO-24 PC board

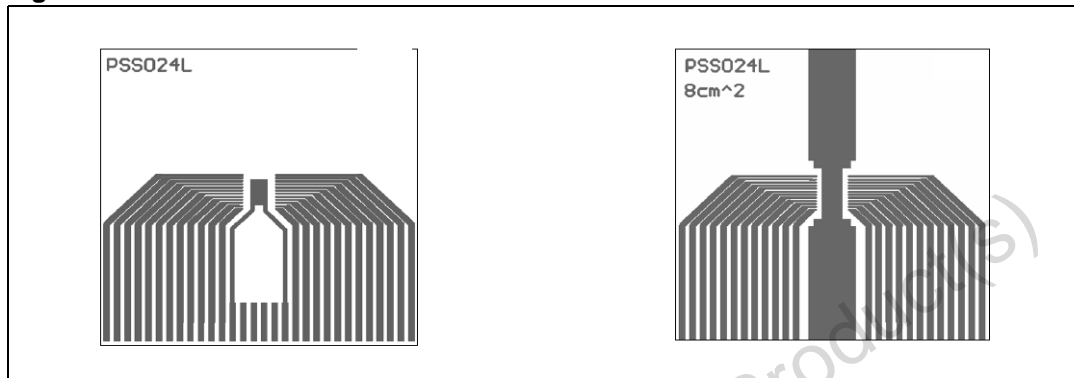

Note: Layout condition of R_{th} and Z_{th} measurements (PCB: Double layer, Thermal Vias, FR4 area= 77mm x 86mm, PCB thickness=1.6mm, Cu thickness=70mm (front and back side), Copper areas: from minimum pad lay-out to 8cm²).

Figure 21. $R_{thj-amb}$ vs PCB copper area in open box free air condition

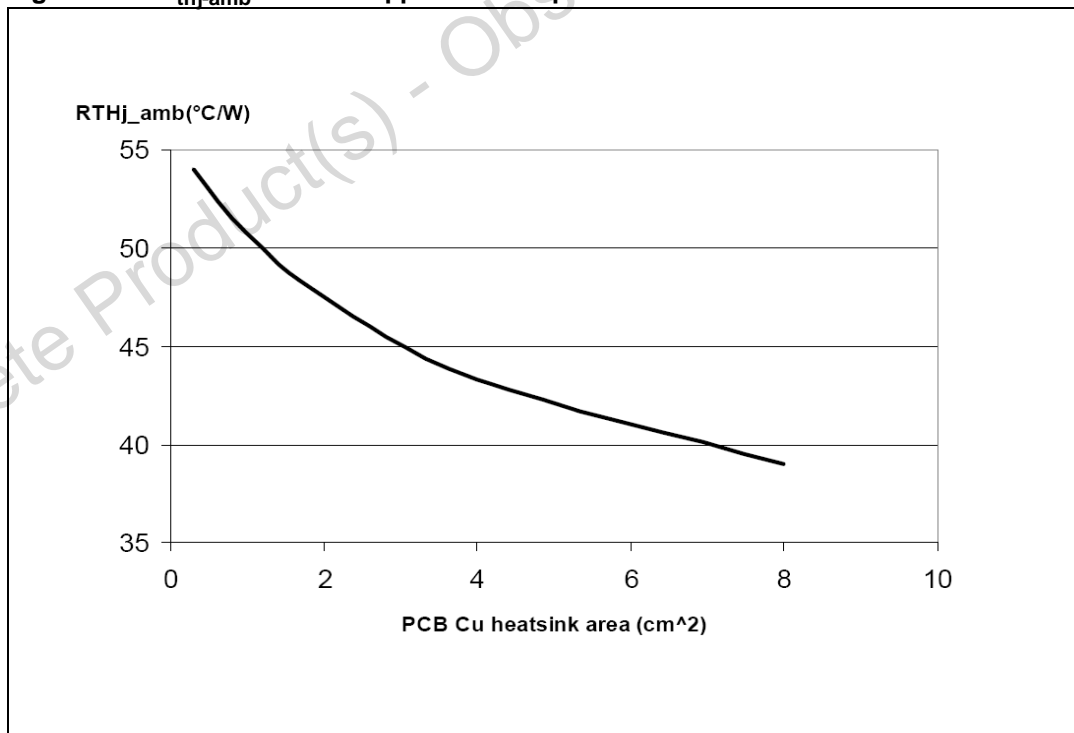
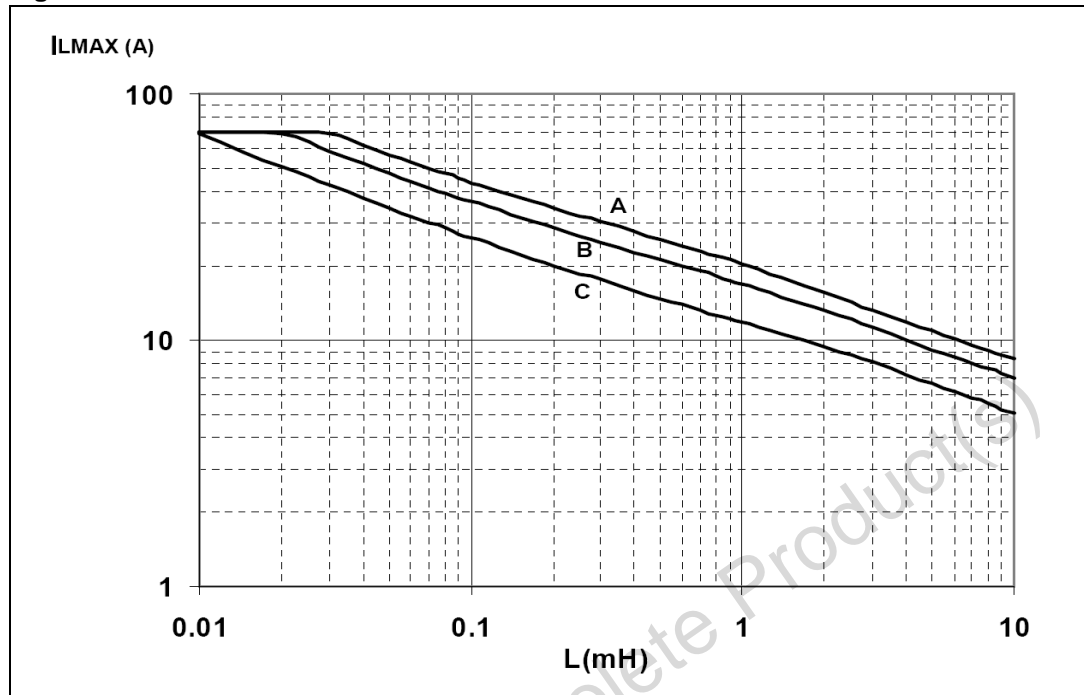

Figure 22. Maximum turn-off current versus load inductance



Legend

A = Single Pulse at $T_{Jstart} = 150^{\circ}C$

B = Repetitive pulse at $T_{Jstart} = 100^{\circ}C$

C = Repetitive Pulse at $T_{Jstart} = 125^{\circ}C$

Conditions:

$V_{CC} = 13.5V$

Values are generated with $R_L=0\Omega$ In case of repetitive pulses, T_{jstart} (at beginning of each demagnetization) of every pulse must not exceed the temperature specified above for curves B and C.

Figure 23. Demagnetization

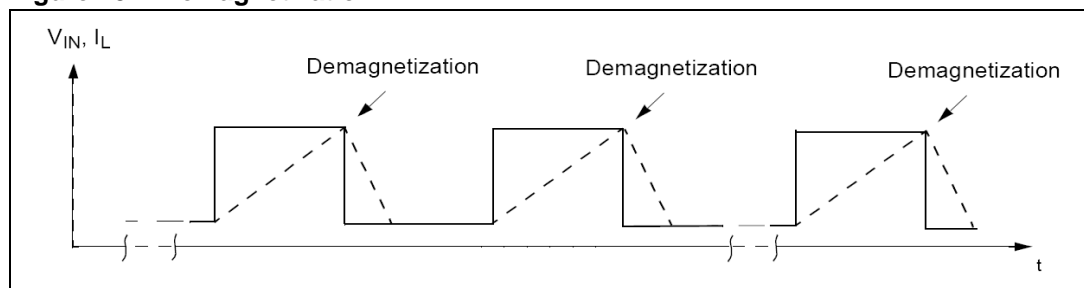

Figure 24. PowerSSO-24 thermal impedance junction ambient single pulse

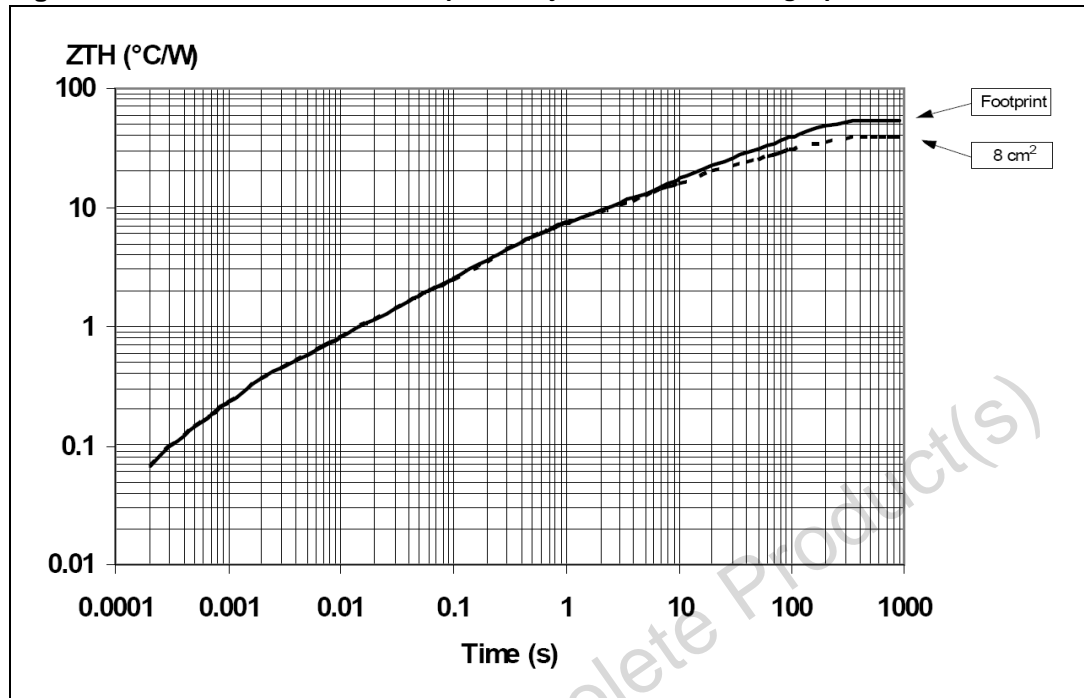
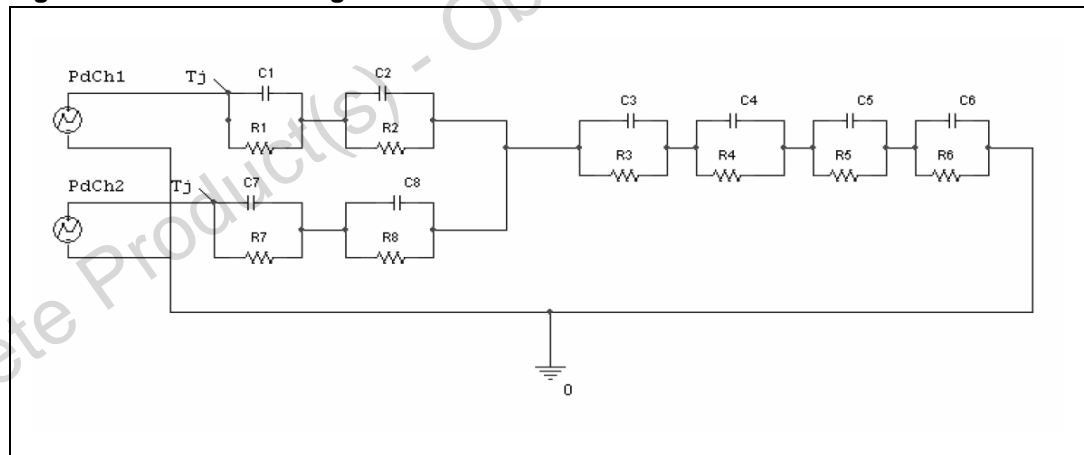

Figure 25. Thermal fitting model of a double channel HSD in PowerSSO-24



Equation 1: pulse calculation formula:

$$Z_{TH\delta} = R_{TH} \cdot \delta + Z_{THtp}(1 - \delta)$$

where $\delta = t_p/T$

Table 15. Thermal parameters

Area/island (cm ²)	Footprint	8
R1 = R7 (°C/W)	0.5	
R2 = R8 (°C/W)	0.3	
R3 (°C/W)	0.9	

Table 15. Thermal parameters (continued)

Area/island (cm ²)	Footprint	8
R4 (°C/W)	5	
R5 (°C/W)	13.5	8
R6 (°C/W)	37	22
C1 = C7 (W.s/°C)	0.001	
C2 = C8 (W.s/°C)	0.005	
C3 (W.s/°C)	0.025	
C4 (W.s/°C)	0.08	
C5 (W.s/°C)	0.7	
C6 (W.s/°C)	3	5

5 Package and packing information

5.1 ECOPACK[®] packages

In order to meet environmental requirements, ST offers these devices in different grades of ECOPACK[®] packages, depending on their level of environmental compliance. ECOPACK[®] specifications, grade definitions and product status are available at: www.st.com.

ECOPACK[®] is an ST trademark.

5.2 PowerSSO-24 mechanical data

Table 16. PowerSSO-24 mechanical data

Symbol	millimeters		
	Min	Typ	Max
A			2.45
A2	2.15		2.35
a1	0		0.1
b	0.33		0.51
c	0.23		0.32
D	10.10		10.50
E	7.4		7.6
e		0.8	
e3		8.8	
F		2.3	
G			0.1
G1			0.06
H	10.1		10.5
h			0.4
k	0°		8°
L	0.55		0.85
N			10deg
X	4.1		4.7
Y	6.5		7.1

Figure 26. PowerSSO-24 package dimensions

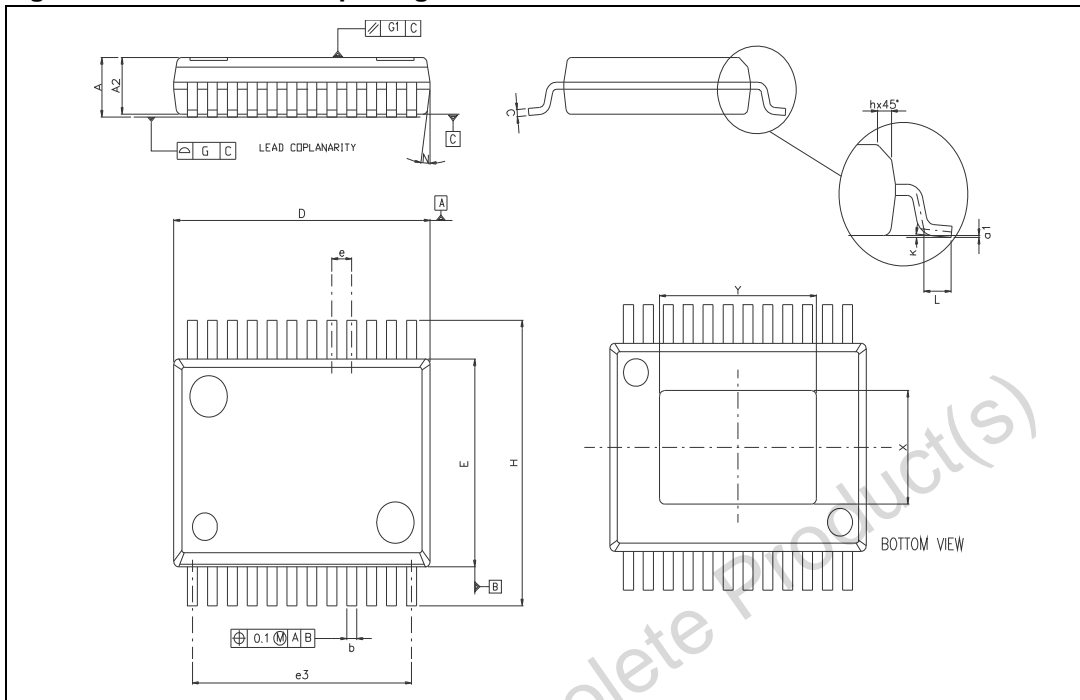

5.3 Packing information

Figure 27. PowerSSO-24 tube shipment (no suffix)

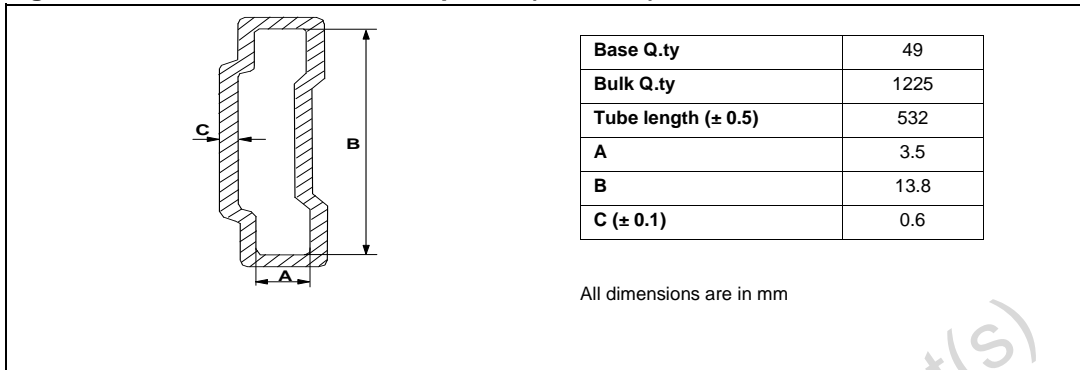
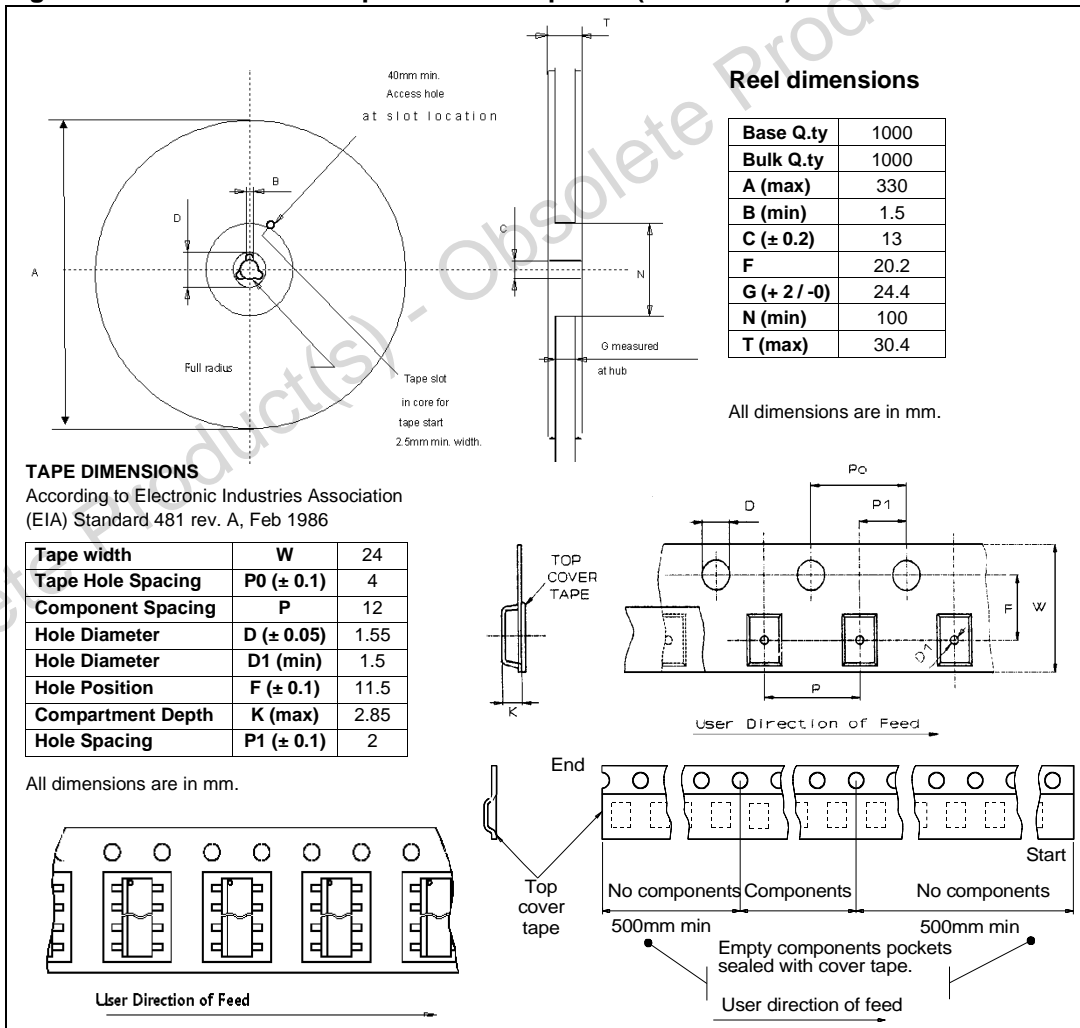

Figure 28. PowerSSO-24 tape and reel shipment (suffix "TR")



6 Revision history

Table 17. Document revision history

Date	Revision	Changes
04-Nov-2004	1	Initial release.
01-Dec-2004	2	$I_{L(off2)}$ removal.
01-Mar-2005	3	<p><i>Table 3: Absolute maximum ratings:</i></p> <ul style="list-style-type: none"> – Added maximum switching energy. <p>Added <i>Section 2.2: Thermal data.</i></p> <p>Added <i>Figure 22: Maximum turn-off current versus load inductance.</i> -</p> <p>Added <i>Figure 24: PowerSSO-24 thermal impedance junction ambient single pulse.</i></p>
01-Apr-2005	4	<p>Modified <i>Figure 2: Configuration diagram (top view)</i></p> <p>Inserted <i>Section 5.3: Packing information</i></p>
13-May-2005	5	Minor changes
24-Jun-2009	6	<p><i>Table 16: PowerSSO-24 mechanical data:</i></p> <ul style="list-style-type: none"> – Deleted A (min) value – Changed A (max) value from 2.47 to 2.45 – Changed A2 (max) value from 2.40 to 2.35 – Changed a1 (max) value from 0.075 to 0.1 – Added F and k rows
23-Sep-2013	7	Updated Disclaimer.

Please Read Carefully:

Information in this document is provided solely in connection with ST products. STMicroelectronics NV and its subsidiaries ("ST") reserve the right to make changes, corrections, modifications or improvements, to this document, and the products and services described herein at any time, without notice.

All ST products are sold pursuant to ST's terms and conditions of sale.

Purchasers are solely responsible for the choice, selection and use of the ST products and services described herein, and ST assumes no liability whatsoever relating to the choice, selection or use of the ST products and services described herein.

No license, express or implied, by estoppel or otherwise, to any intellectual property rights is granted under this document. If any part of this document refers to any third party products or services it shall not be deemed a license grant by ST for the use of such third party products or services, or any intellectual property contained therein or considered as a warranty covering the use in any manner whatsoever of such third party products or services or any intellectual property contained therein.

UNLESS OTHERWISE SET FORTH IN ST'S TERMS AND CONDITIONS OF SALE ST DISCLAIMS ANY EXPRESS OR IMPLIED WARRANTY WITH RESPECT TO THE USE AND/OR SALE OF ST PRODUCTS INCLUDING WITHOUT LIMITATION IMPLIED WARRANTIES OF MERCHANTABILITY, FITNESS FOR A PARTICULAR PURPOSE (AND THEIR EQUIVALENTS UNDER THE LAWS OF ANY JURISDICTION), OR INFRINGEMENT OF ANY PATENT, COPYRIGHT OR OTHER INTELLECTUAL PROPERTY RIGHT.

ST PRODUCTS ARE NOT DESIGNED OR AUTHORIZED FOR USE IN: (A) SAFETY CRITICAL APPLICATIONS SUCH AS LIFE SUPPORTING, ACTIVE IMPLANTED DEVICES OR SYSTEMS WITH PRODUCT FUNCTIONAL SAFETY REQUIREMENTS; (B) AERONAUTIC APPLICATIONS; (C) AUTOMOTIVE APPLICATIONS OR ENVIRONMENTS, AND/OR (D) AEROSPACE APPLICATIONS OR ENVIRONMENTS. WHERE ST PRODUCTS ARE NOT DESIGNED FOR SUCH USE, THE PURCHASER SHALL USE PRODUCTS AT PURCHASER'S SOLE RISK, EVEN IF ST HAS BEEN INFORMED IN WRITING OF SUCH USAGE, UNLESS A PRODUCT IS EXPRESSLY DESIGNATED BY ST AS BEING INTENDED FOR "AUTOMOTIVE, AUTOMOTIVE SAFETY OR MEDICAL" INDUSTRY DOMAINS ACCORDING TO ST PRODUCT DESIGN SPECIFICATIONS. PRODUCTS FORMALLY ESCC, QML OR JAN QUALIFIED ARE DEEMED SUITABLE FOR USE IN AEROSPACE BY THE CORRESPONDING GOVERNMENTAL AGENCY.

Resale of ST products with provisions different from the statements and/or technical features set forth in this document shall immediately void any warranty granted by ST for the ST product or service described herein and shall not create or extend in any manner whatsoever, any liability of ST.

ST and the ST logo are trademarks or registered trademarks of ST in various countries.

Information in this document supersedes and replaces all information previously supplied.

The ST logo is a registered trademark of STMicroelectronics. All other names are the property of their respective owners.

© 2013 STMicroelectronics - All rights reserved

STMicroelectronics group of companies

Australia - Belgium - Brazil - Canada - China - Czech Republic - Finland - France - Germany - Hong Kong - India - Israel - Italy - Japan - Malaysia - Malta - Morocco - Philippines - Singapore - Spain - Sweden - Switzerland - United Kingdom - United States of America

www.st.com