

Series PVT422PbF

Microelectronic Power IC
HEXFET® Power MOSFET Photovoltaic Relay
Dual Pole, Normally Open
0-400V, 120mA AC/DC

General Description

The PVT422 Series Photovoltaic Relay is a dual-pole, normally open solid-state relay that can replace electromechanical relays in many applications. It utilizes International Rectifier's HEXFET power MOSFET as the output switch, driven by an integrated circuit photovoltaic generator of novel construction. The output switch is controlled by radiation from a GaAlAs light emitting diode (LED) which is optically isolated from the photovoltaic generator.

Series PVT422 Relays are packaged in an 8-pin, molded DIP package with either thru-hole or surface mount (gull-wing) terminals. It is available in standard plastic shipping tubes or on tape-and-reel. Please refer to Part Identification information opposite.

Features

- HEXFET Power MOSFET output
- Bounce-free operation
- 4,000 V_{RMS} I/O isolation
- Linear AC/DC operation
- Solid-State Reliability
- UL recognized and BABT certified

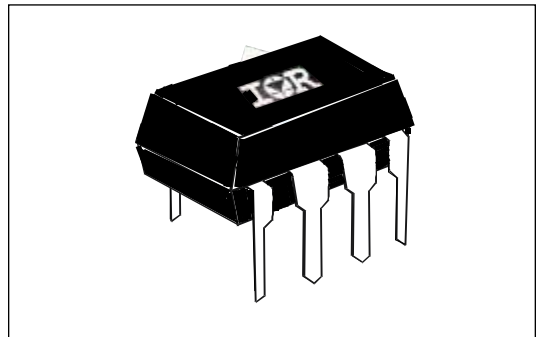

Applications

- On/Off Hook switch
- Dial-Out relay
- Ring injection relay
- General switching

Part Identification

| | |
|--------------|---------------------------------|
| PVT422PbF | thru-hole |
| PVT422SPbF | surface-mount |
| PVT422S-TPbF | surface-mount, Tape and Reel |

(HEXFET is the registered trademark for International Rectifier Power MOSFETs)

Electrical Specifications ($-40^{\circ}\text{C} \leq T_A \leq +85^{\circ}\text{C}$ unless otherwise specified)

| INPUT CHARACTERISTICS | Limits | Units |
|--|-----------|-------|
| Minimum Control Current (See figure 1) | 2.0 | mA |
| Maximum Control Current for Off-State Resistance @TA=+25°C | 0.4 | mA |
| Control Current Range (Caution: current limit input LED, see figure 5) | 2.0 to 25 | mA |
| Maximum Reverse Voltage | 6.0 | V |

| OUTPUT CHARACTERISTICS | Limits | Units |
|---|-----------|------------------|
| Operating Voltage Range | 0 to ±400 | V(DC or AC peak) |
| Maximum Load Current @ TA=+40°C 5mA Control (See figure 1) (single and dual channel operation) | 120 | mA |
| Maximum Peak Load Current (10ms maximum duration) (single and dual channel operation) | 350 | mA |
| Maximum On-State Resistance @TA=+25°C For 50mA Pulsed load, 5mA Control (see figure 3) | 35 | Ω |
| Maximum Off-State Leakage @TA=+25°C, ±320V (see figure 4) | 1.0 | μA |
| Maximum Turn-On Time @TA=+25°C (see figure 6) For 50mA, 100 Vdc load, 5mA Control | 2.0 | ms |
| Maximum Turn-Off Time @TA=+25°C (see figure 6) For 50mA, 100 Vdc load, 5mA Control | 2.0 | ms |
| Maximum Output Capacitance @ 50Vdc | 12 | pF |

| GENERAL CHARACTERISTICS | Limits | Units | |
|---|------------------|------------------|-------------|
| Minimum Dielectric Strength, Input-Output | 4000 | V _{RMS} | |
| Minimum Dielectric Strength, Pole-to-Pole | 1000 | V _{dc} | |
| Minimum Insulation Resistance, Input-Output, @TA=+25°C, 50%RH, 100Vdc | 10 ¹² | Ω | |
| Maximum Capacitance, Input-Output | 1.0 | pF | |
| Maximum Pin Soldering Temperature (10 seconds maximum) | +260 | °C | |
| Ambient Temperature Range: | Operating | | -40 to +85 |
| | Storage | | -40 to +100 |

International Rectifier does not recommend the use of this product in aerospace, avionics, military or life support applications. Users of this International Rectifier product in such applications assume all risks of such use and indemnify International Rectifier against all damages resulting from such use.

Connection Diagram

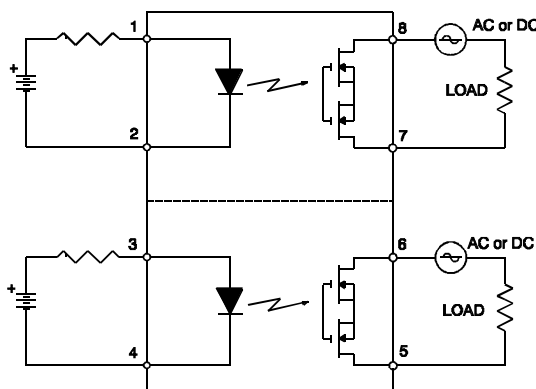

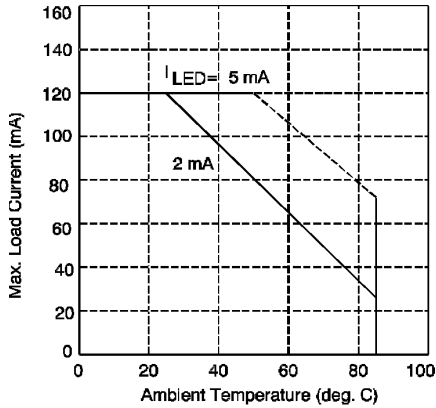

Figure 1. Typical Current Derating Curve

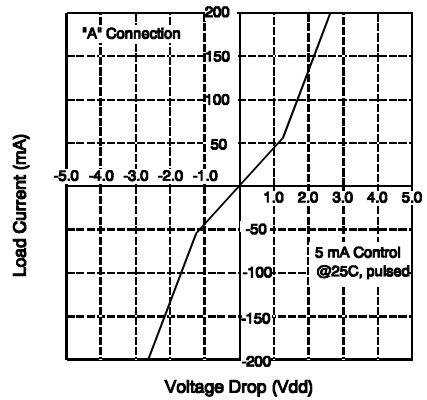

Figure 2. Linearity Characteristics

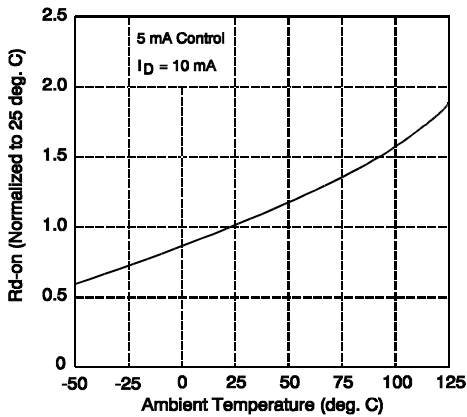

Figure 3. Typical Normalized On-Resistance

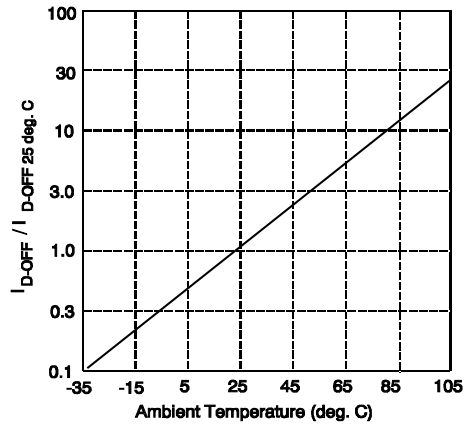

Figure 4. Typical Normalized Off-State Leakage

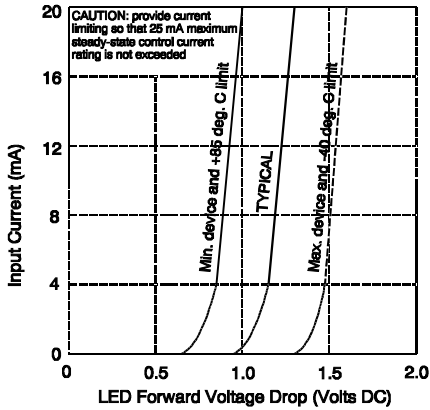

Figure 5. Input Characteristics (Current Controlled)

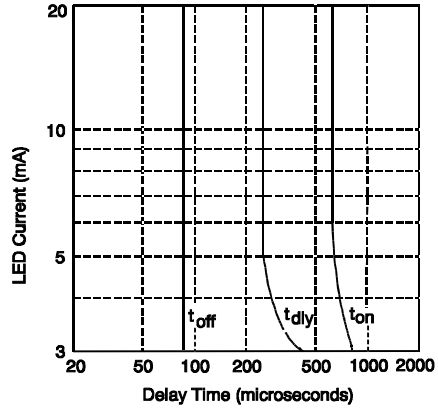

Figure 6. Typical Delay Times

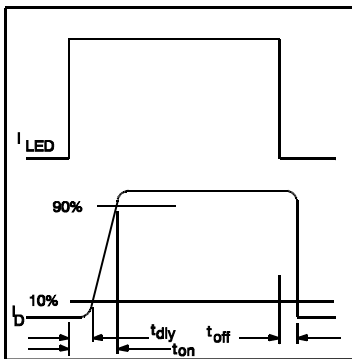

Figure 7. Delay Time Definitions

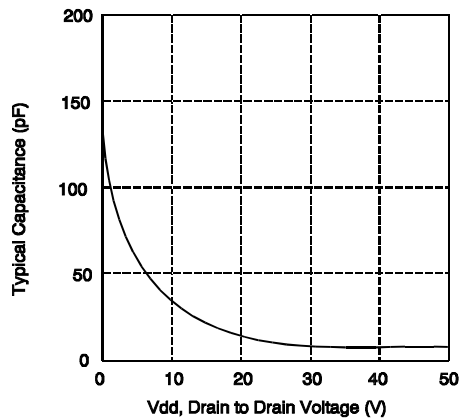
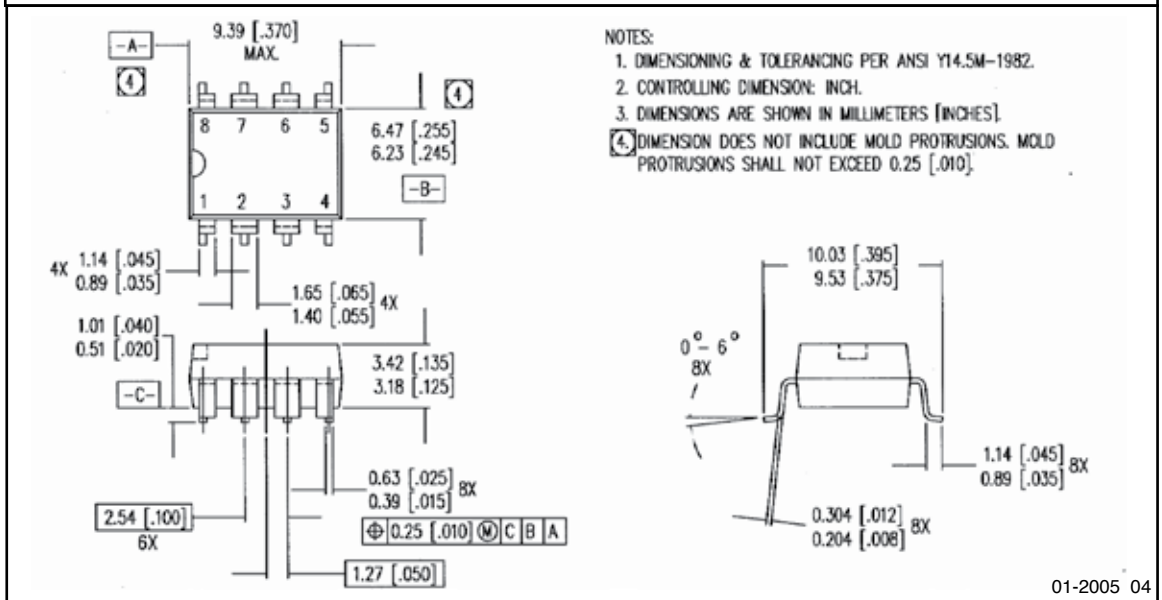
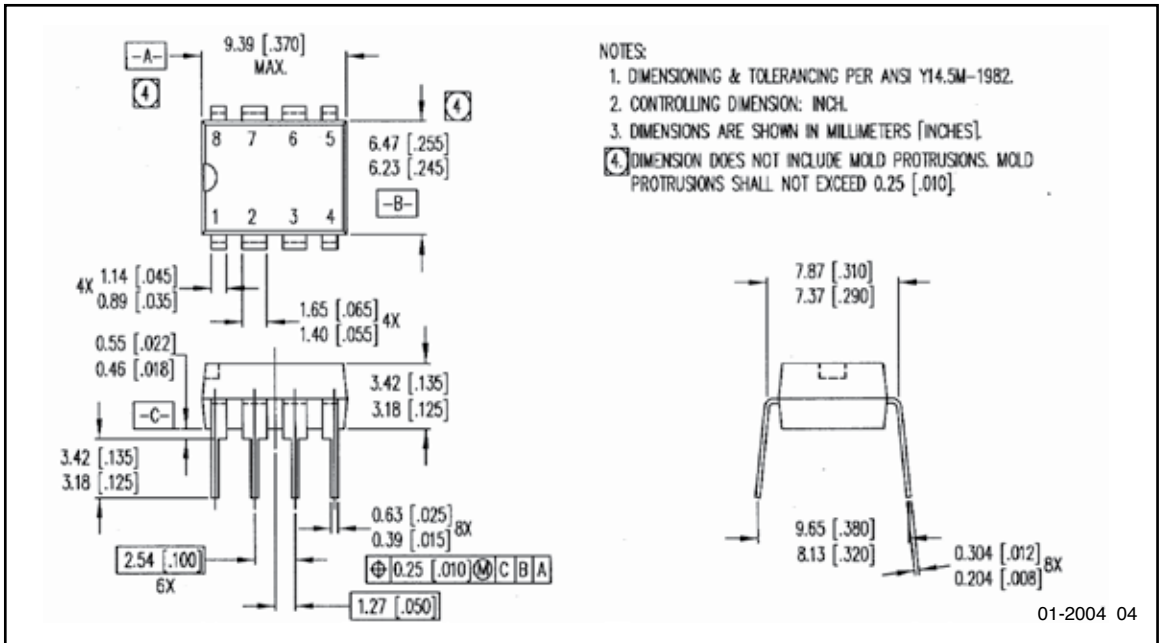

Figure 8. Typical Output Capacitance

Case Outlines



IR WORLD HEADQUARTERS: 233 Kansas St., El Segundo, California 90245 Tel: (310) 252-7105
 Data and specifications subject to change without notice. 2/2008