

NCP1522

3.0 MHz, 600 mA, High-Efficiency, Low Quiescent Current, Adjustable Output Voltage Step-Down Converter

The NCP1522 step-down PWM DC-DC converter is optimized for portable applications powered from one cell Li-ion or three cell Alkaline/NiCd/NiMH batteries. The device is available in an adjustable output voltage from 0.9 V to 3.3 V. It uses synchronous rectification to increase efficiency and reduce external part count. The device also has a built-in 3.0 MHz (nominal) oscillator which reduces component size by allowing a small inductor and capacitors. Automatic switching PWM/PFM mode offers improved system efficiency.

Finally, it includes an integrated soft-start, cycle-by-cycle current limiting, and thermal shutdown protection. The NCP1522 is available in a space saving, low profile TSOP5 package.

Features

- 93.8% of Efficiency for 3.3 V Output and 4.5 V Input and 120 mA Load Current
- Sources up to 600 mA
- 3.0 MHz Switching Frequency
- Adjustable Output Voltage from 0.9 V to 3.3 V
- 60 μ A Quiescent Current (Typ)
- Synchronous Rectification for Higher Efficiency
- 2.7 V to 5.5 V Input Voltage Range
- Thermal Limit Protection
- Shutdown Current Consumption of 0.3 μ A
- Short Circuit Protection
- This is a Pb-Free Device

Typical Applications

- Cellular Phones, Smart Phones and PDAs
- MP3 Players and Portable Audio Systems
- Wireless and DSL Modems
- Portable Equipment
- USB Powered Devices
- Digital Still/Video Cameras

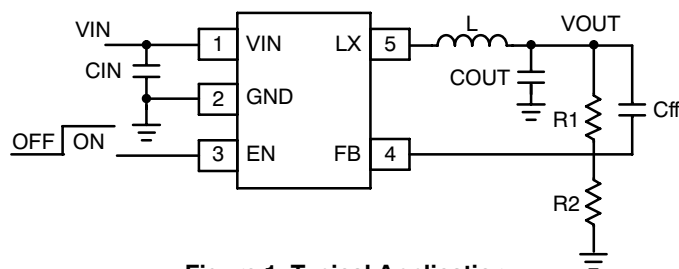

Figure 1. Typical Application



ON Semiconductor®

<http://onsemi.com>

MARKING DIAGRAM



TSOP-5
ASN SUFFIX
CASE 483

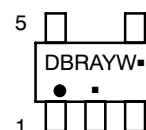

A = Assembly Location
Y = Year
W = Work Week
▪ = Pb-Free Package
(Note: Microdot may be in either location)

PIN CONNECTIONS

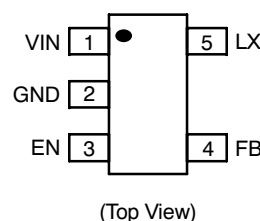

ORDERING INFORMATION

Device	Package	Shipping
NCP1522ASNT1G	TSOP-5 (Pb-Free)	3000/Tape & Reel

†For information on tape and reel specifications, including part orientation and tape sizes, please refer to our Tape and Reel Packaging Specification Brochure, BRD8011/D.

NCP1522

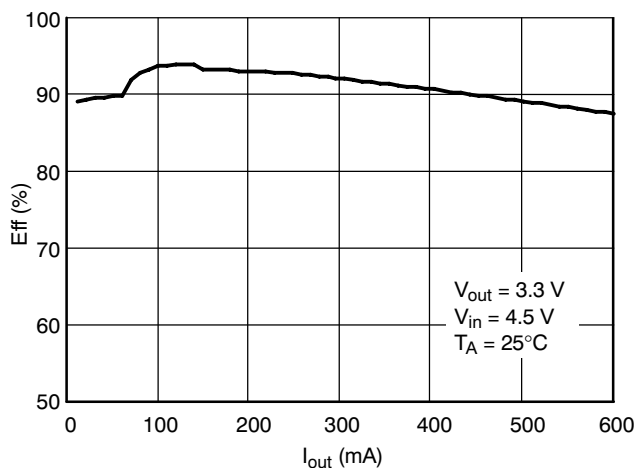

Figure 2. Efficiency vs. Output Current

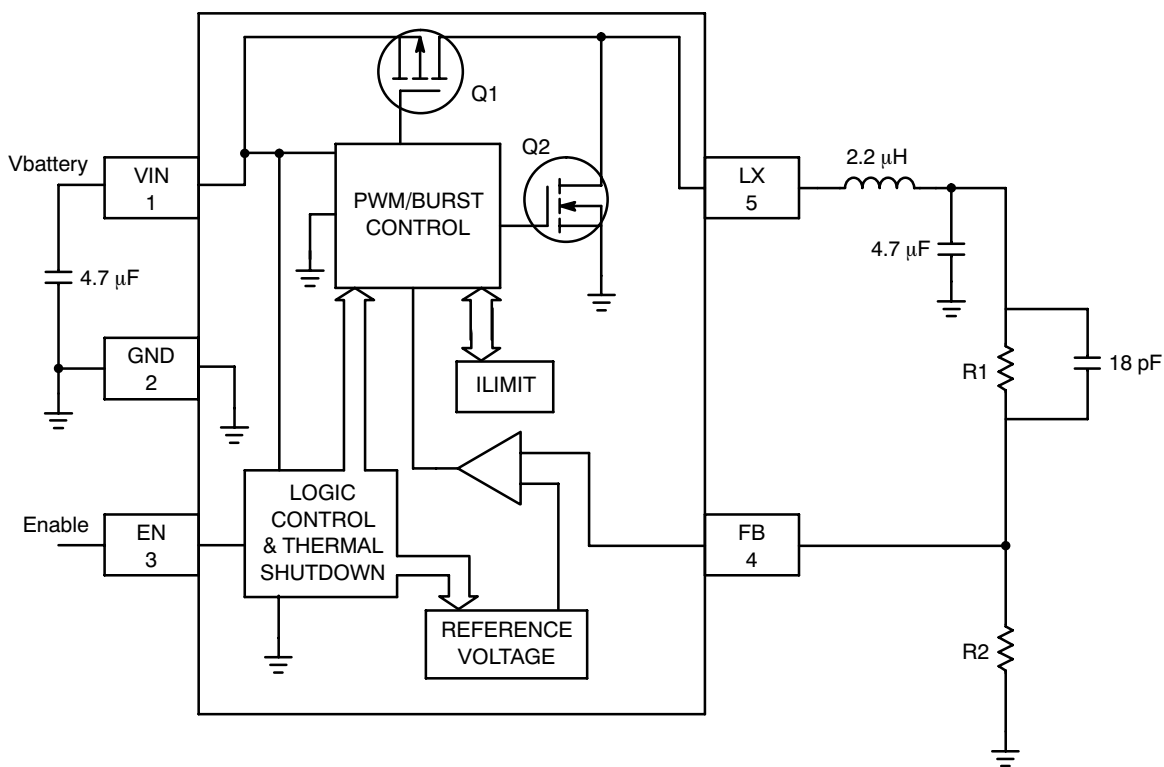

Figure 3. Simplified Block Diagram

NCP1522

PIN FUNCTION DESCRIPTION

Pin No.	Symbol	Function	Description
1	VIN	Analog Input	Power Supply Input for Analog V_{CC} .
2	GND	Analog/Power Ground	Ground connection for the NFET Power Stage and the Analog Sections of the IC.
3	EN	Digital Input	Enable for Switching Regulator. This pin is active high. Do not float this pin.
4	FB	Analog Input	Feedback voltage from the output of the power supply. This is the input to the error amplifier.
5	LX	Analog Output	Connection from Power MOSFETs to the Inductor. For one option, an output discharge circuit sinks current from this pin.

MAXIMUM RATINGS

Rating	Symbol	Value	Unit
Minimum Voltage All Pins	V_{min}	-0.3	V
Maximum Voltage All Pins (Note 1)	V_{max}	7.0	V
Maximum Voltage Enable, FB, LX	V_{max}	$V_{IN} + 0.3$	V
Thermal Resistance, Junction -to-Air	$R_{\theta JA}$	300	$^{\circ}C/W$
Operating Ambient Temperature Range	T_A	-40 to 85	$^{\circ}C$
Storage Temperature Range	T_{stg}	-55 to 150	$^{\circ}C$
Junction Operating Temperature	T_j	-40 to 125	$^{\circ}C$
Latch-up Current Maximum Rating ($T_A = 85^{\circ}C$) (Note 2)	Lu	+/-100	mA
ESD Withstand Voltage (Note 3)	Vesd		
Human Body Model		2.0	kV
Machine Model		200	V

Stresses exceeding Maximum Ratings may damage the device. Maximum Ratings are stress ratings only. Functional operation above the Recommended Operating Conditions is not implied. Extended exposure to stresses above the Recommended Operating Conditions may affect device reliability.

1. According to JEDEC standard JESD22-A108B.
2. Latchup current maximum rating per JEDEC standard: JESD78.
3. This device series contains ESD protection and exceeds the following tests:
 Human Body Model (HBM) per JEDEC standard: JESD22-A114.
 Machine Model (MM) per JEDEC standard: JESD22-A115.

NCP1522

ELECTRICAL CHARACTERISTICS (Typical values are referenced to $T_A = +25^\circ\text{C}$, Min and Max values are referenced -40°C to $+85^\circ\text{C}$ ambient temperature, unless otherwise noted, operating conditions $V_{IN} = 3.6\text{ V}$, $V_{OUT} = 1.8\text{ V}$, unless otherwise noted.)

Characteristic	Symbol	Min	Typ	Max	Unit
Input Voltage Range	V_{IN}	2.7	-	5.5	V
Undervoltage Lockout (V_{IN} Falling)	V_{UVLO}	2.3	2.5	2.6	V
Quiescent Current (PFM No Load)	I_q	-	60	95	μA
Standby Current, EN Low	I_{stb}	-	0.3	1.2	μA
Oscillator Frequency	F_{osc}	2.400	3.0	3.600	MHz
Peak Inductor Current	I_{LIM}	-	1200	-	mA
Feedback Reference Voltage	V_{ref}	-	0.6	-	V
FB Pin Tolerance	V_{FBtol}	-3.0	-	3.0	%
Reference Voltage Line Regulation	ΔV_{FB}	-	0.1	-	%
Output Voltage Accuracy (Note 4)	V_{OUT}	-3%	V_{nom}	+3%	V
Minimum Output Voltage	V_{OUT}	-	0.9	-	V
Maximum Output Voltage	V_{OUT}	-	3.3	-	V
Output Voltage Line Regulation ($V_{in} = 2.7\text{--}5.5$) $I_o = 200\text{ mA}$	ΔV_{OUT}	-	0.1	-	%
Voltage Load Regulation ($I_O = 200\text{ mA to }300\text{ mA}$) ($I_O = 200\text{ mA to }600\text{ mA}$)	$V_{LOADREG}$	-	0.0005 0.001	-	%/mA %/mA
Load Transient Response (300 mA to 600 mA Load Step, Trise 1.0 μs)	V_{OUT}	-	35	-	mV
Duty Cycle	-	-	-	100	%
P-Ch On-Resistance	$RLxH$	-	300	-	$\text{m}\Omega$
N-Ch On-Resistance	$RLxL$	-	300	-	$\text{m}\Omega$
P-Ch Leakage Current	I_{LeakH}	-	0.05	-	μA
N-Ch Leakage Current	I_{LeakL}	-	0.01	-	μA
Enable Pin High	V_{ENH}	1.2	-	-	V
Enable Pin Low	V_{ENL}	-	-	0.4	V
EN << H >> Input Current, EN = 3.6 V	I_{ENH}	-	2.0	-	μA
Soft-Start Time	T_{start}	-	350	500	μs
Thermal Shutdown Threshold	T_{SD}	-	160	-	$^\circ\text{C}$
Thermal Shutdown Hysteresis	T_{SDH}	-	25	-	$^\circ\text{C}$

4. The overall output voltage tolerance depends upon the accuracy of the external resistor (R_1 , R_2).

NCP1522

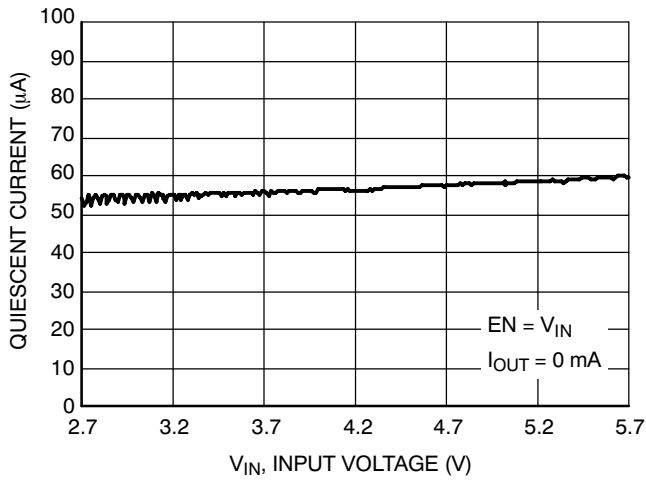

Figure 4. Quiescent Current vs. Supply Voltage

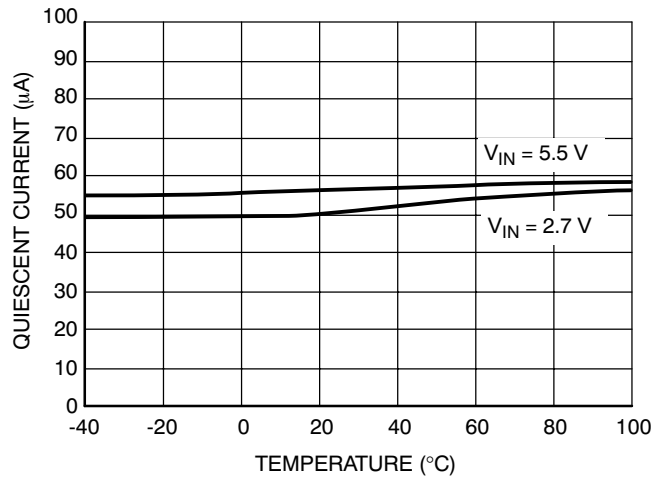

Figure 5. Quiescent Current vs. Temperature

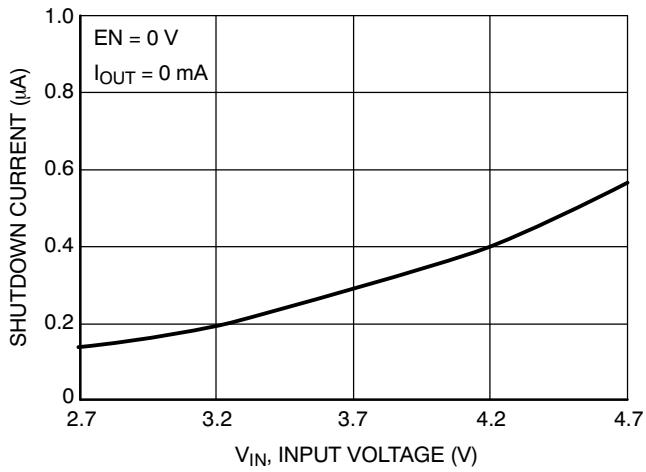

Figure 6. Shutdown Current vs. Supply Voltage

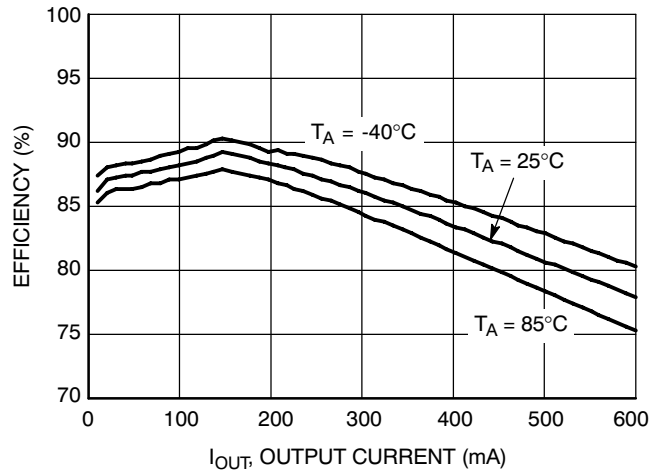

Figure 7. Efficiency vs. Output Current
($V_{\text{OUT}} = 1.8 \text{ V}$, $V_{\text{IN}} = 3.6 \text{ V}$)

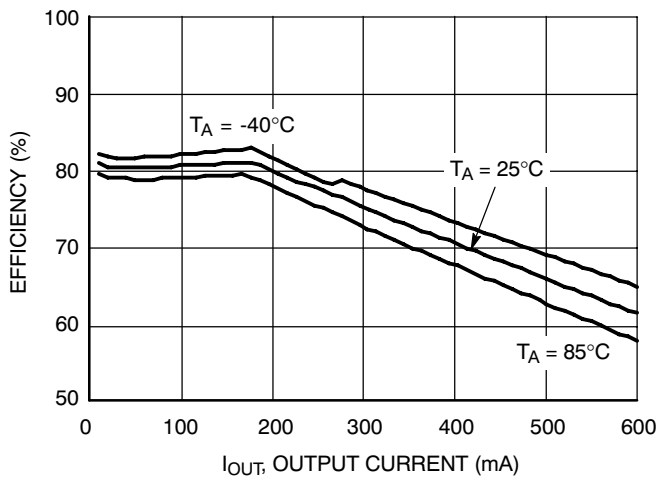

Figure 8. Efficiency vs. Output Current
($V_{\text{OUT}} = 0.9 \text{ V}$, $V_{\text{IN}} = 3.6 \text{ V}$)

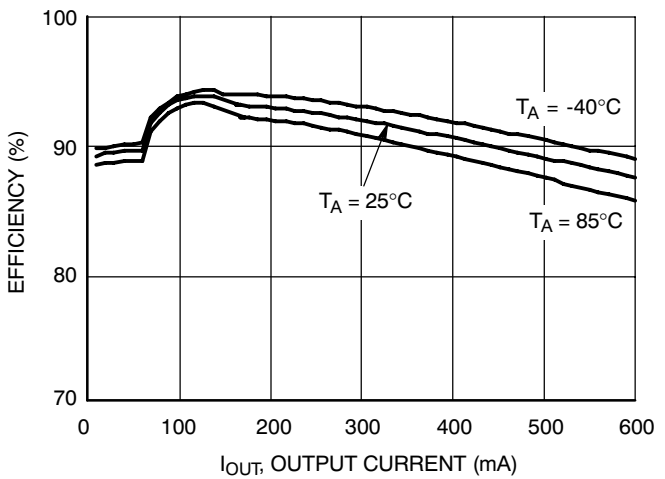

Figure 9. Efficiency vs. Output Current
($V_{\text{OUT}} = 3.3 \text{ V}$, $V_{\text{IN}} = 4.5 \text{ V}$)

NCP1522

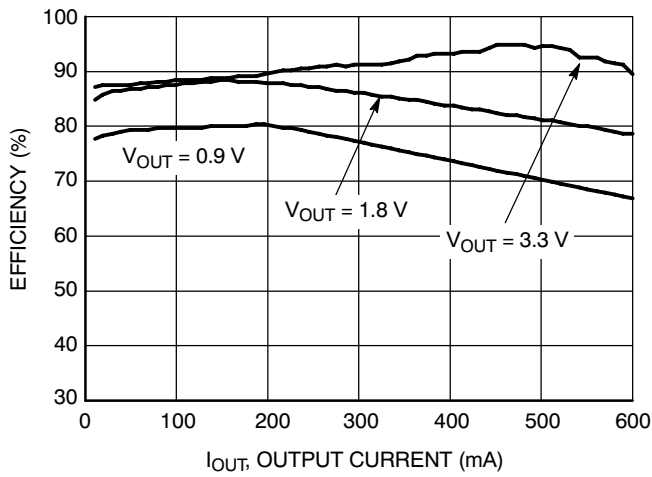

Figure 10. Efficiency vs. Output Current
($V_{IN} = 4.0\text{ V}$)

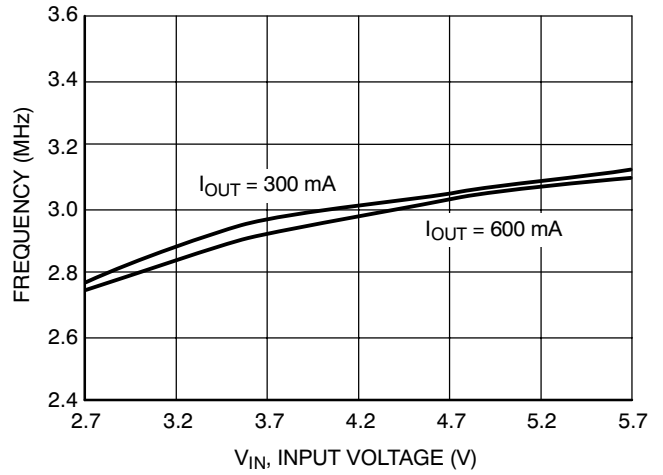

Figure 11. Frequency vs. Input Voltage

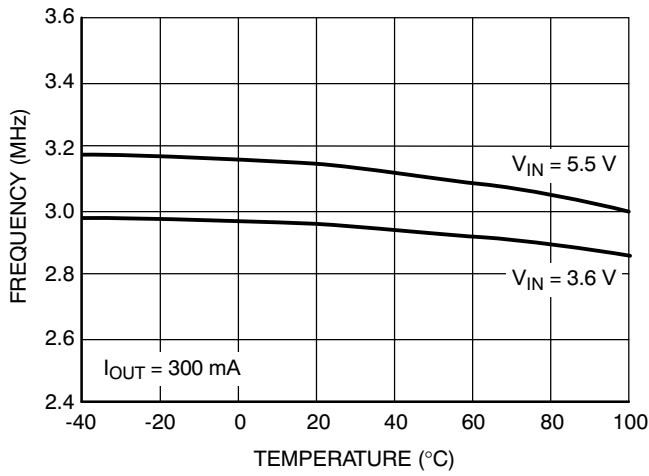

Figure 12. Frequency vs. Temperature

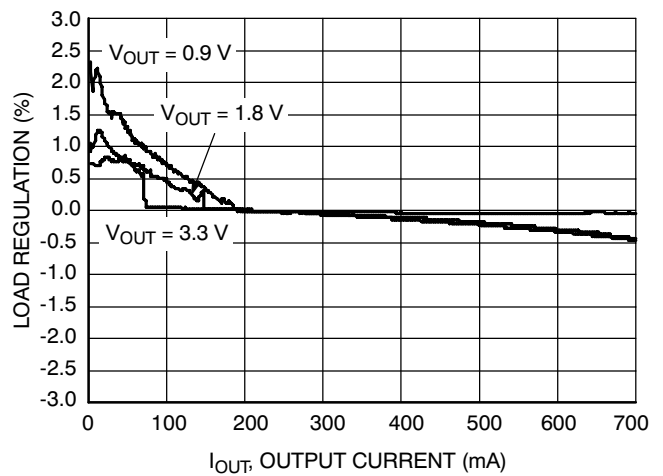

Figure 13. Load Regulation

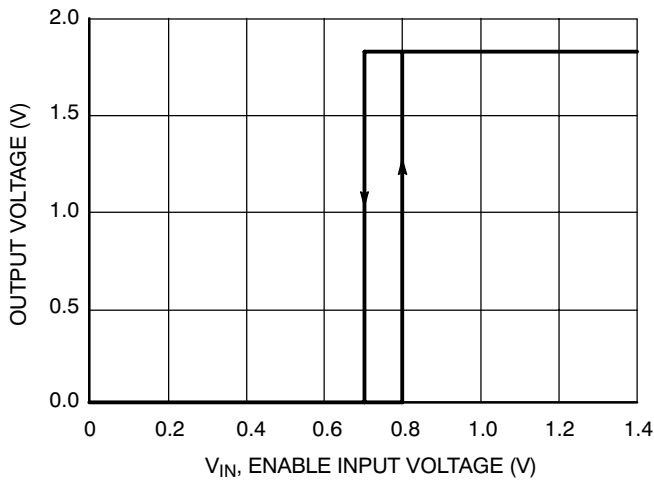

Figure 14. Output Voltage vs. Enable Input Pin Voltage

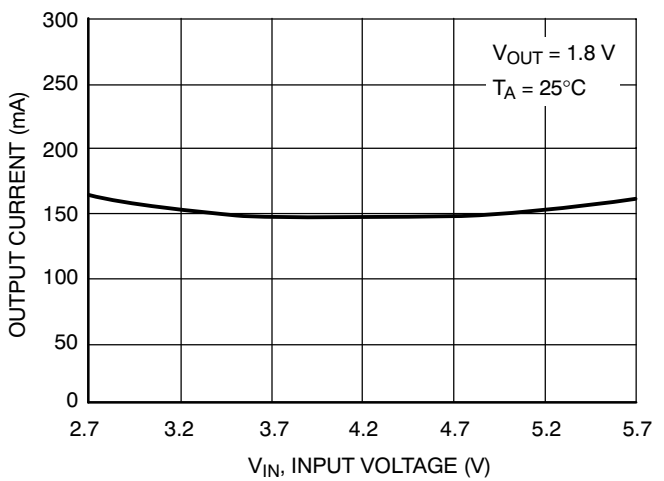

Figure 15. PFM/PWM Threshold vs. Input Voltage

NCP1522

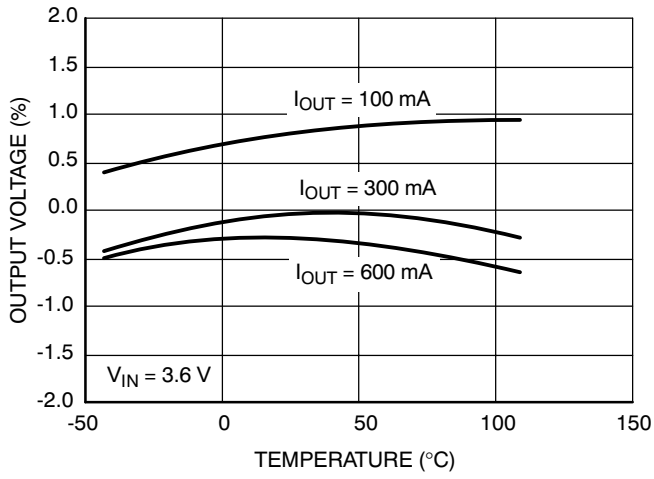

Figure 16. Output Voltage Accuracy
(V_{OUT} = 0.9 V)

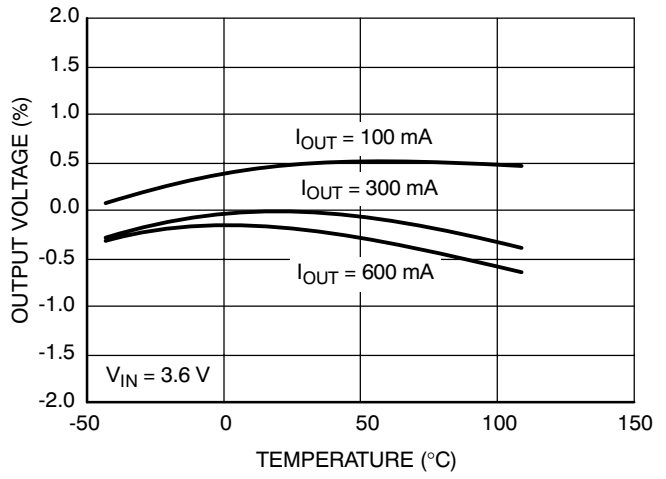

Figure 17. Output Voltage Accuracy
(V_{OUT} = 1.8 V)

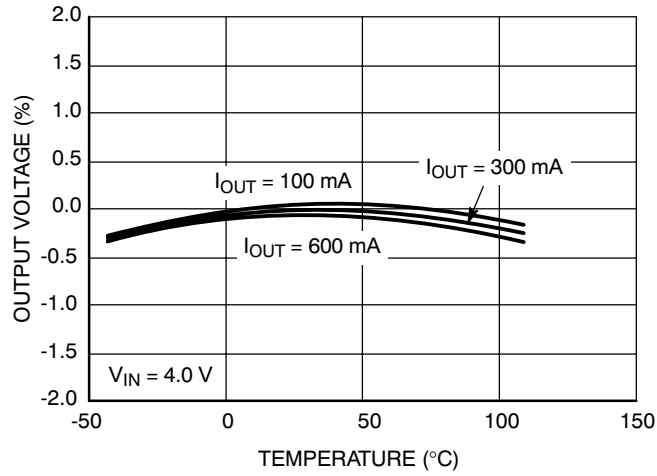

Figure 18. Output Voltage Accuracy
(V_{OUT} = 3.3 V)

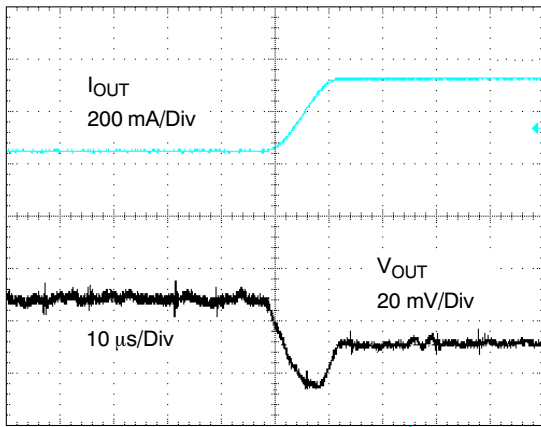

Figure 19. Load Transient Response in PWM Operation ($V_{IN} = 3.6\text{ V}$)

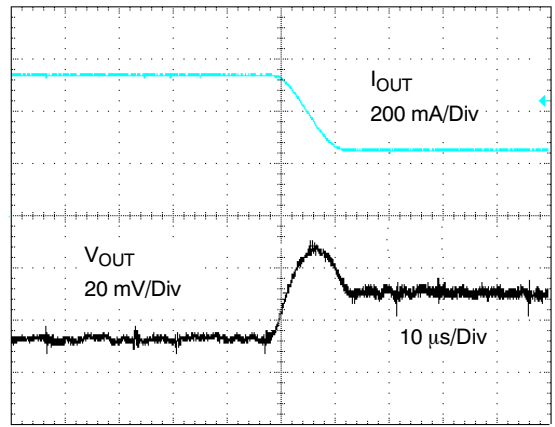

Figure 20. Load Transient Response in PWM Operation ($V_{IN} = 3.6\text{ V}$)

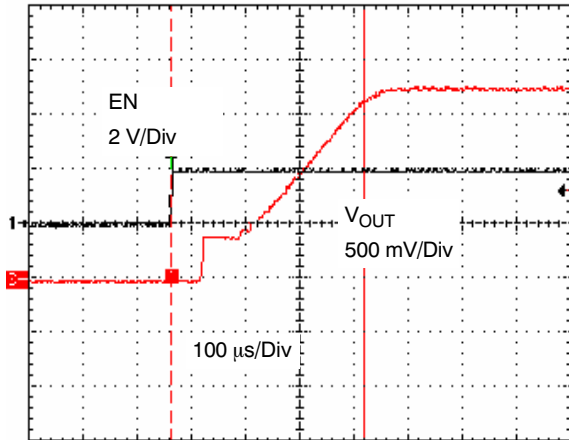

Figure 21. Soft Start Time ($V_{IN} = 3.6\text{ V}$)

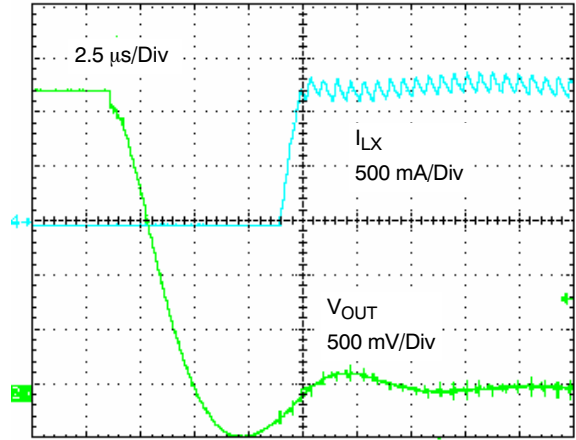

Figure 22. Short Circuit Protection ($V_{IN} = 3.6\text{ V}$)

OPERATION DESCRIPTION

Overview

The NCP1522 uses a constant frequency, voltage mode step-down architecture. Both the main (P-Channel MOSFET) and synchronous (N-Channel MOSFET) switches are internal.

It delivers a constant voltage from either a single Li-Ion or three cell NiMH/NiCd battery to portable devices such as cell phones and PDA. The output voltage is set by external resistor divider. The NCP1522 sources at least 600 mA depending on external components chosen.

The NCP1522 works with two modes of operation; PWM depending on the current required. The device operates in PWM/PFM mode at load currents of approximately 80 mA or higher, having voltage tolerance of $\pm 3\%$ with 90% efficiency or better. Lighter load currents cause the device to automatically switch into PFM mode for reduced current consumption ($I_Q = 60 \mu\text{A}$ typ) and extended battery life.

Additional features include soft-start, undervoltage protection, current overload protection, and thermal shutdown protection. As shown in Figure 1, only six external components are required for implementation. The part uses an internal reference voltage of 0.6 V. It is recommended to keep the part in shutdown until the input voltage is 2.7 V or higher.

PWM Operating Mode

In this mode, the output voltage of the NCP1522 is regulated by modulating the on-time pulse width of the main switch Q1 at a fixed frequency of 3.0 MHz. The switching of the PMOS Q1 is controlled by a flip-flop driven by the internal oscillator and a comparator that compares the error signal from an error amplifier with the PWM ramp. At the beginning of each cycle, the main switch Q1 is turned ON by the rising edge of the internal oscillator clock. The inductor current ramps up until the sum of the current sense signal and compensation ramp becomes higher than the error voltage amplifier. Once this has occurred, the PWM comparator resets the flip-flop, Q1 is turned OFF and the synchronous switch Q2 is turned ON. Q2 replaces the external Schottky diode to reduce the conduction loss and improve the efficiency. To avoid overall power loss, a certain amount of dead time is introduced to ensure Q1 is completely turned OFF before Q2 is being turned ON.

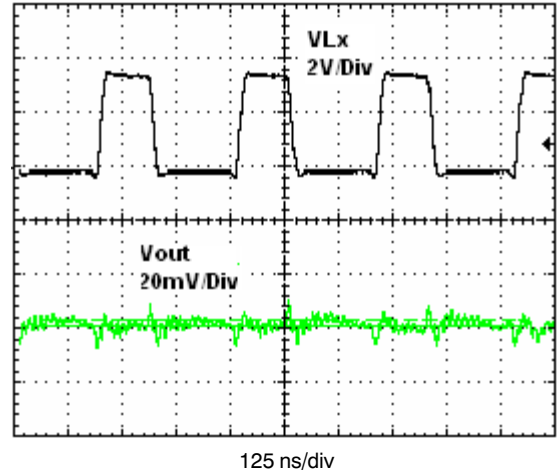

Figure 23. PWM Switching Waveform
($V_{in} = 3.6 \text{ V}$, $V_{out} = 1.8 \text{ V}$, $I_{out} = 300 \text{ mA}$)

PFM Operating Mode

Under light load conditions, the NCP1522 enters in low current PFM mode operation to reduce power consumption. The output regulation is implemented by pulse frequency modulation. If the output voltage drops below the threshold of PFM comparator (typically $V_{nom} - 2\%$), a new cycle will be initiated by the PFM comparator to turn on the switch Q1. Q1 remains ON until the peak inductor current reaches 200 mA (nom). Then I_{LIM} comparator goes high to switch off Q1. After a short dead time delay, switch rectifier Q2 is turned ON. The negative current detector (NCD) will detect when the inductor current drops below zero and sends the signal to turn off Q2. The output voltage continues to decrease through discharging the output capacitor. When the output voltage falls below the threshold of the PFM comparator, a new cycle starts immediately.

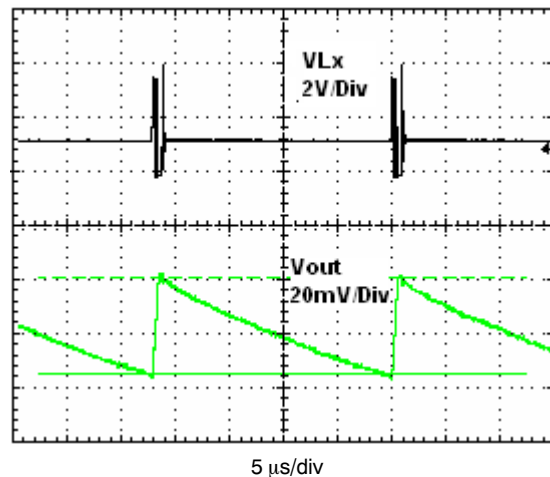

Figure 24. PFM Mode Switching Waveform
($V_{in} = 3.6 \text{ V}$, $V_{out} = 1.8 \text{ V}$, $I_{out} = 30 \text{ mA}$)

Cycle-by-Cycle Current Limitation

From the block diagram (Figure 3), an I_{LIM} comparator is used to realize cycle-by-cycle current limit protection. The comparator compares the LX pin voltage with the reference voltage, which is biased by a constant current. If the inductor current reaches the limit, the I_{LIM} comparator detects the LX voltage falling below the reference voltage and releases the signal to turn off the switch Q1. The cycle-by-cycle current limit is set at 1200 mA (nom).

Short Circuit Protection

When the output is shorted to ground, the device limits the inductor current. The duty-cycle is minimum and the consumption on the input line is 300 mA (Typ). When the short circuit condition is removed, the device returns to the normal mode of operation.

Soft-Start

The NCP1522 uses soft-start (300 μ s Typ) to limit the inrush current when the device is initially enabled. Soft-start is implemented by gradually increasing the reference voltage until it reaches the full reference voltage. During startup, a pulsed current source charges the internal soft-start capacitor to provide gradually increasing reference voltage. When the voltage across the capacitor ramps up to the nominal reference voltage, the pulsed current source will be switched off and the reference voltage will switch to the regular reference voltage.

Shutdown Mode

When the EN pin has a voltage applied of less than 0.4 V, the NCP1522 will be disabled. In shutdown mode, the internal reference, oscillator and most of the control circuitries are turned off. Therefore, the typical current

consumption will be 0.3 μ A (typical value). Applying a voltage above 1.2 V to EN pin will enable the device for normal operation. The device will go through soft-start to normal operation, however, the EN pin should be tied low while the input voltage on V_{IN} pin is rising up.

Thermal Shutdown

Internal Thermal Shutdown circuitry is provided to protect the integrated circuit in the event that the maximum junction temperature is exceeded. If the junction temperature exceeds 160°C, the device shuts down. In this mode switch Q1 and Q2 and the control circuits are all turned off. The device restarts in soft-start after the temperature drops below 135°C. This feature is provided to prevent catastrophic failures from accidental device overheating and it is not intended as a substitute for proper heatsinking.

Low Dropout Operation

The NCP1522 offers a low input to output voltage difference. The NCP1522 can operate at 100% duty cycle. In this mode the PMOS (Q1) switches completely on.

The minimum input voltage to maintain regulation can be calculated as:

$$V_{IN(min)} = V_{OUT(max)} + (I_{OUT} \times (R_{DS(on)} + R_{INDUCTOR})) \quad (\text{eq. 1})$$

- V_{OUT} : Output Voltage (Volts)
- I_{OUT} : Max Output Current
- $R_{DS(on)}$: P-Channel Switch $R_{DS(on)}$
- $R_{INDUCTOR}$: Inductor Resistance (DCR)

APPLICATION INFORMATION

Output Voltage Selection

The output voltage is programmed through an external resistor divider connected from V_{OUT} to FB then to GND. For low power consumption and noise immunity, the resistor from FB to GND (R2) should be in the [100 k-600 k] range. If R2 is 200 k given the V_{FB} is 0.6 V, the current through the divider will be 3.0 μA.

The formula below gives the value of V_{OUT}, given the desired R1 and the R1 value:

$$V_{OUT} = V_{FB} \times \left(1 + \frac{R1}{R2}\right) \quad (\text{eq. 2})$$

- V_{OUT}: Output Voltage (Volts)
- V_{FB}: Feedback Voltage = 0.6 V
- R1: Feedback Resistor from V_{OUT} to FB
- R2: Feedback Resistor from FB to GND

Input Capacitor Selection

In PWM operating mode, the input current is pulsating with large switching noise. Using an input bypass capacitor can reduce the peak current transients drawn from the input supply source, thereby reducing switching noise significantly. The capacitance needed for the input bypass capacitor depends on the source impedance of the input supply.

The maximum RMS current occurs at 50% duty cycle with maximum output current, which is IO, max/2.

For NCP1522, a low profile, low ESR ceramic capacitor of 4.7 μF should be used for most of the cases. For effective bypass results, the input capacitor should be placed as close as possible to the V_{IN} pin.

Table 1. List of Input Capacitor

Murata	GRM188R60J475KE
	GRM21BR71C475KA
Taiyo Yuden	JMK212BY475MG
TDK	C2012X5ROJ475KB
	C1632X5ROJ475KT

Output L-C Filter Design Considerations

The NCP1522 is built in 3.0 MHz frequency and uses voltage mode architecture. The correct selection of the output filter ensures good stability and fast transient response.

Due to the nature of the buck converter, the output L-C filter must be selected to work with internal compensation. For NCP1522, the internal compensation is internally fixed and it is optimized for an output filter of L = 2.2 μH and C_{OUT} = 4.7 μF.

The corner frequency is given by:

$$f_c = \frac{1}{2\pi\sqrt{L \times C_{OUT}}} = \frac{1}{2\pi\sqrt{2.2 \mu\text{H} \times 4.7 \mu\text{F}}} = 49.5 \text{ kHz} \quad (\text{eq. 3})$$

The device is intended to operate with inductance between 1.0 μH and maximum of 4.7 μH.

If the corner frequency is moved, it is recommended to check the loop stability depending on the output ripple voltage accepted and output current required. For lower frequency, the stability will be increased; a larger output capacitor value could be chosen without critical effect on the system. On the other hand, a smaller capacitor value increases the corner frequency and it should be critical for the system stability. Take care to check the loop stability. The phase margin is usually higher than 45°.

Table 2. L-C Filter Example

Inductance (L)	Output Capacitor (C _{out})
1.0 μH	10 μF
2.2 μH	4.7 μF
4.7 μH	2.2 μF

Inductor Selection

The inductor parameters directly related to device performances are saturation current and DC resistance and inductance value. The inductor ripple current (ΔI_L) decreases with higher inductance:

$$\Delta I_L = \frac{V_{OUT}}{L \times f_{SW}} \left(1 - \frac{V_{OUT}}{V_{IN}}\right) \quad (\text{eq. 4})$$

ΔI_L peak to peak inductor ripple current

L inductor value

f_{SW} switching frequency

The saturation current of the inductor should be rated higher than the maximum load current plus half the ripple current:

$$I_{L(MAX)} = I_{O(MAX)} + \frac{\Delta I_L}{2} \quad (\text{eq. 5})$$

I_{L(MAX)} Maximum Inductor Current

I_{O(MAX)} Maximum Output Current

The inductor's resistance will factor into the overall efficiency of the converter. For best performances, the DC resistance should be less than 0.3 Ω for good efficiency.

Table 3. List of Inductor

FDK	MIPW3226 Series
TDK	VLF3010AT Series
Taiyo Yuden	LQ CBL2012
Coil craft	DO1605-T Series
	LPO3010

Output Capacitor Selection

Selecting the proper output capacitor is based on the desired output ripple voltage. Ceramic capacitors with low ESR values will have the lowest output ripple voltage and are strongly recommended. The output capacitor requires either an X7R or X5R dielectric.

The output ripple voltage in PWM mode is given by:

$$\Delta V_{OUT} = \Delta I_L \times \left(\frac{1}{4 \times f_{SW} \times C_{OUT}} + ESR \right) \quad (\text{eq. 6})$$

In PFM mode (at light load), the output voltage is regulated by pulse frequency modulation. The output voltage ripple is independent of the output capacitor value. It is set by the threshold of PFM comparator.

Table 4. List of Output Capacitor

Murata	GRM188R60J475KE	4.7 μ F
	GRM21BR60J106ME19L	10 μ F
	GRM188R60OJ106ME	10 μ F
Taiyo Yuden	JMK212BY475MG	4.7 μ F
	JMK212BJ106MG	10 μ F
TDK	C2012X5ROJ475KB	4.7 μ F
	C1632X5ROJ475KT	4.7 μ F
	C2012X5ROJ106K	10 μ F

Feed-Forward Capacitor Selection

The feed-forward capacitor sets the feedback loop response and is critical to obtain good loop stability.

Given that the compensation is internally fixed, an 18 pF or higher ceramic capacitor is needed. Choose a small ceramic capacitor X7R or X5R or COG dielectric.

NCP1522

APPLICATION BOARD

PCB Layout Recommendations

Good PCB layout plays an important role in switching mode power conversion. Careful PCB layout can help to minimize ground bounce, EMI noise and unwanted feedback that can affect the performance of the converter. Hints suggested below can be used as a guideline in most situations.

1. Use star-ground connection to connect the IC ground nodes and capacitor GND nodes together at one point. Keep them as close as possible, and then connect this to the ground plane through several vias. This will reduce noise in the ground plane by preventing the switching currents from flowing through the ground plane.

2. Place the power components (i.e., input capacitor, inductor and output capacitor) as close together as possible for best performance. All connecting traces must be short, direct, and wide to reduce voltage errors caused by resistive losses through the traces.
3. Separate the feedback path of the output voltage from the power path. Keep this path close to the NCP1522 circuit. And also route it away from noisy components. This will prevent noise from coupling into the voltage feedback trace.
4. Place the DC-DC converter away from noise sensitive circuitry, such as RF circuits.

The following shows the NCP1522 demo board schematic, layout, and bill of materials:

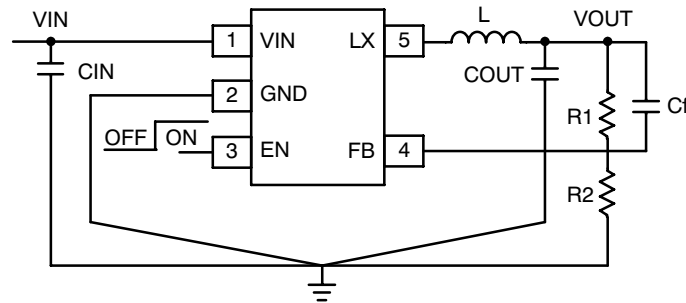

Figure 25. NCP1522 Board Schematic

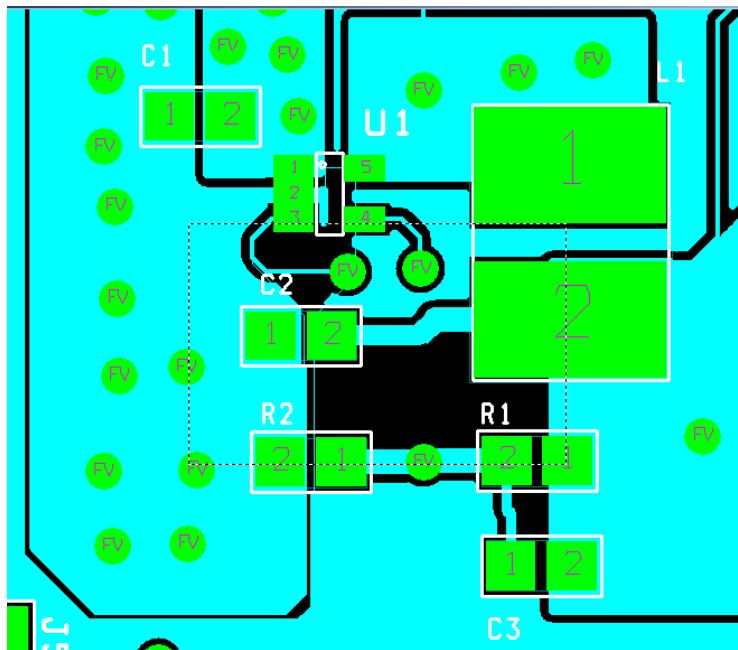

Figure 26. NCP1522 Board Layout

NCP1522

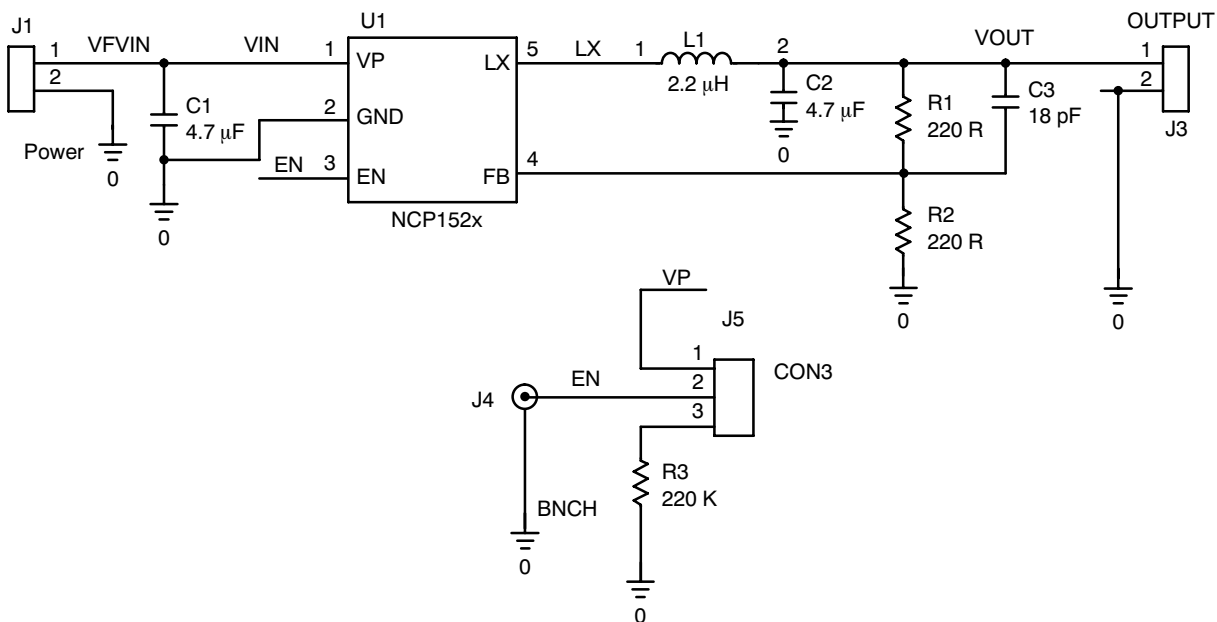

Figure 27. Schematics

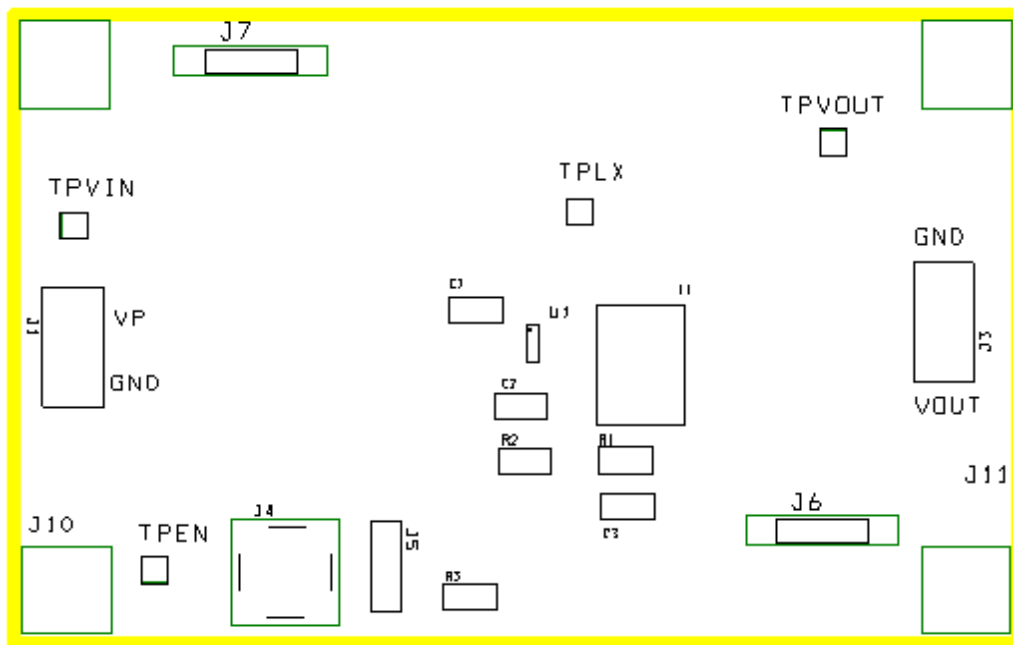

Figure 28. Silkscreen Layer

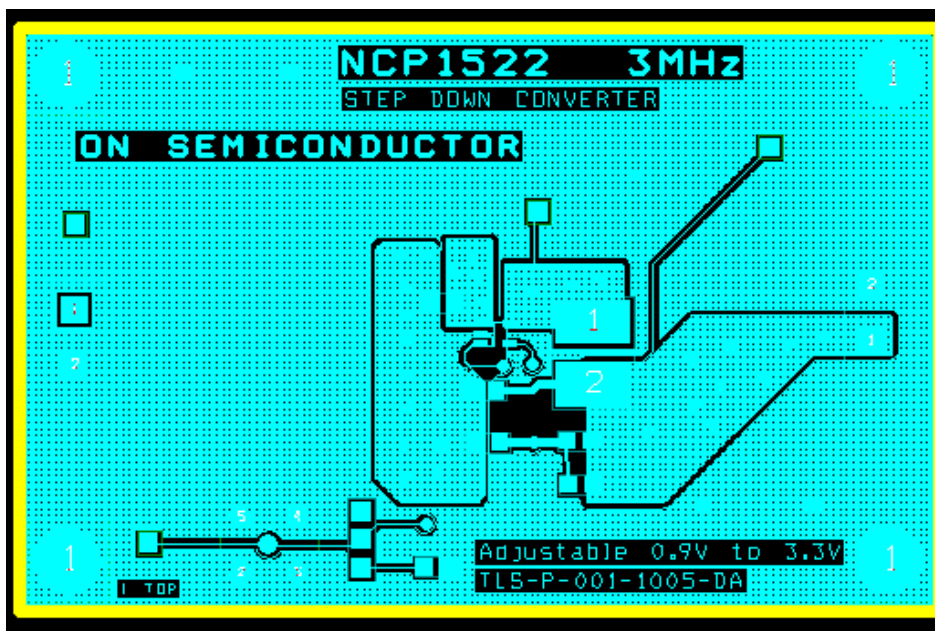

Figure 29. Board Layout (Top View)

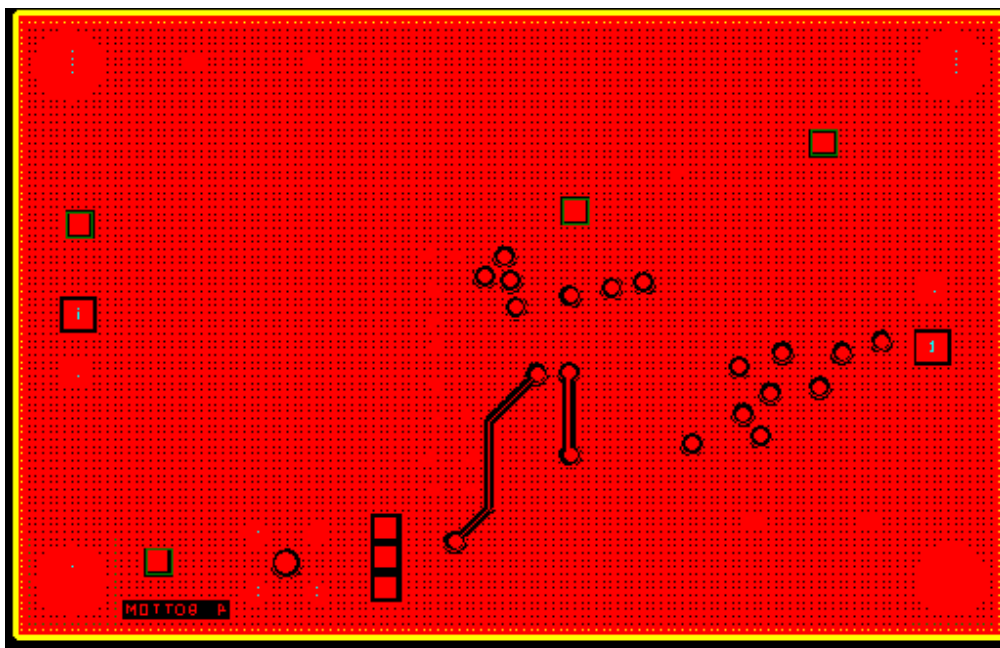

Figure 30. Board Layout (Bottom View)

NCP1522

Bill of Materials

Item	Part Description	Ref	PCB Footprint	Manufacturer	Manufacturer Reference
1	NCP1522 DC-DC Converter	U1	TSOP-5	On Semiconductor	NCP1522
2	4.7 μ F Ceramic Capacitor 6.3 V X5R	C1, C2	0805	Murata	GRM21 Series
3	18 pF Ceramic Capacitor 50 V COG	C3	0603	Murata	GRM188 Series
4	SMD Resistor 220 K	R1, R2, R3	0805	Vishay-Draloric	CRCW0805
5	SMD Inductor	L1	1605	Coilcraft	DO1605 Series
6	I/O Connector can be plugged by BLZ5.08/2 (Weidmüller reference)	J1, J3	-	Weidmüller	SL5.08/2/90B
7	Jumper Header vertical mount 3*1, 2.54 mm	J5	-	Tyco Electronics/AMP	5-826629-0
8	Jumper Connector, 400 mils	J6, J7	-	Harwin	D3082-B01

NCP1522

PACKAGE DIMENSIONS

TSOP-5
SN SUFFIX
CASE 483-02
ISSUE G

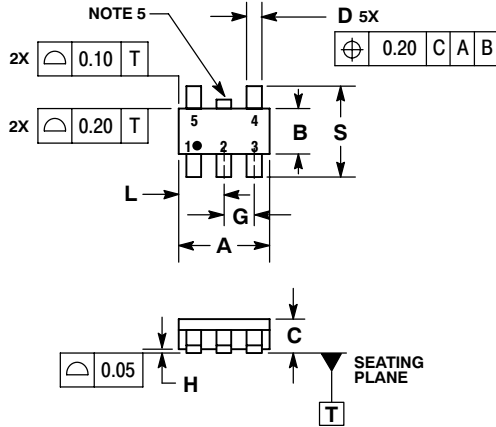

NOTES:

1. DIMENSIONING AND TOLERANCING PER ASME Y14.5M, 1994.
2. CONTROLLING DIMENSION: MILLIMETERS.
3. MAXIMUM LEAD THICKNESS INCLUDES LEAD FINISH THICKNESS. MINIMUM LEAD THICKNESS IS THE MINIMUM THICKNESS OF BASE MATERIAL.
4. DIMENSIONS A AND B DO NOT INCLUDE MOLD FLASH, PROTRUSIONS, OR GATE BURRS.
5. OPTIONAL CONSTRUCTION: AN ADDITIONAL TRIMMED LEAD IS ALLOWED IN THIS LOCATION. TRIMMED LEAD NOT TO EXTEND MORE THAN 0.2 FROM BODY.

DIM	MILLIMETERS	
	MIN	MAX
A	3.00 BSC	
B	1.50 BSC	
C	0.90	1.10
D	0.25	0.50
G	0.95 BSC	
H	0.01	0.10
J	0.10	0.26
K	0.20	0.60
L	1.25	1.55
M	0°	10°
S	2.50	3.00

SOLDERING FOOTPRINT*

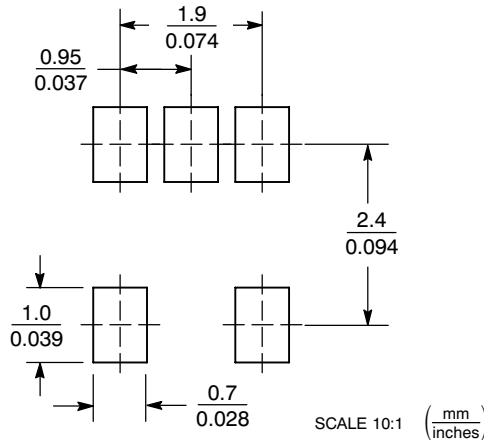

*For additional information on our Pb-Free strategy and soldering details, please download the ON Semiconductor Soldering and Mounting Techniques Reference Manual, SOLDERRM/D.

ON Semiconductor and are registered trademarks of Semiconductor Components Industries, LLC (SCILLC). SCILLC reserves the right to make changes without further notice to any products herein. SCILLC makes no warranty, representation or guarantee regarding the suitability of its products for any particular purpose, nor does SCILLC assume any liability arising out of the application or use of any product or circuit, and specifically disclaims any and all liability, including without limitation special, consequential or incidental damages. "Typical" parameters which may be provided in SCILLC data sheets and/or specifications can and do vary in different applications and actual performance may vary over time. All operating parameters, including "Typicals" must be validated for each customer application by customer's technical experts. SCILLC does not convey any license under its patent rights nor the rights of others. SCILLC products are not designed, intended, or authorized for use as components in systems intended for surgical implant into the body, or other applications intended to support or sustain life, or for any other application in which the failure of the SCILLC product could create a situation where personal injury or death may occur. Should Buyer purchase or use SCILLC products for any such unintended or unauthorized application, Buyer shall indemnify and hold SCILLC and its officers, employees, subsidiaries, affiliates, and distributors harmless against all claims, costs, damages, and expenses, and reasonable attorney fees arising out of, directly or indirectly, any claim of personal injury or death associated with such unintended or unauthorized use, even if such claim alleges that SCILLC was negligent regarding the design or manufacture of the part. SCILLC is an Equal Opportunity/Affirmative Action Employer. This literature is subject to all applicable copyright laws and is not for resale in any manner.

PUBLICATION ORDERING INFORMATION

LITERATURE FULFILLMENT:
Literature Distribution Center for ON Semiconductor
P.O. Box 5163, Denver, Colorado 80217 USA
Phone: 303-675-2175 or 800-344-3860 Toll Free USA/Canada
Fax: 303-675-2176 or 800-344-3867 Toll Free USA/Canada
Email: orderlit@onsemi.com

N. American Technical Support: 800-282-9855 Toll Free
USA/Canada
Europe, Middle East and Africa Technical Support:
Phone: 421 33 790 2910
Japan Customer Focus Center
Phone: 81-3-5773-3850

ON Semiconductor Website: www.onsemi.com
Order Literature: <http://www.onsemi.com/orderlit>

For additional information, please contact your local Sales Representative